



N-Tron[®] Series

NT24k[®] Modular Series

Managed Gigabit Ethernet Switches

Hardware Manual | July 2017

COPYRIGHT

©2015-2017 Red Lion Controls, Inc. All rights reserved. Red Lion, the Red Lion logo, N-Tron, and NT24k are registered trademarks of Red Lion Controls, Inc. All other company and product names are trademarks of their respective owners.

Red Lion Controls, Inc.
20 Willow Springs Circle
York, PA 17406

CONTACT INFORMATION:

Inside US: +1 (877) 432-9908
Outside US: +1 (717) 767-6511

Website: www.redlion.net

Email: support@redlion.net

Table of Contents

Preface	iii
Disclaimer	iii
Compliance Information	iii
FCC Statement	iii
Déclaration de conformité FCC	iii
Industry Canada / Industrie Canada	iv
Environmental Impact Statement	iv
Toxic Emissions	iv
Trademark and Registration Acknowledgments	iv
Release Notes and Document Updates	iv
Publication History	iv
Related Documents	v
Document Comments	v
Additional Product Information	v
Cautions and Warnings / Mises en Garde et Avertissements	v
General Safety Cautions and Warnings / Précautions et Avertissements de Sécurité Générale	v
Electrical Safety Warnings / Avertissements de Sécurité électrique	vi
Environmental Safety Cautions and Warnings / Sécurité Environnementale Mises en Garde et Avertissements	vii
Hazardous Location Warnings / Les Avertissements d'Emplacement Dangereux	vii
Surrounding Air Temperature / Temperature Ambiante	viii
Laser Safety Warnings / Avertissements de Sécurité Laser	viii
Regulatory Information	ix
Product Safety	ix
Emissions	ix
Immunity	ix
Other	ix
Chapter 1 Product Overview	1-1
1.1 NT24k® Modular Series Common Features	1-1
1.1.1 Connectivity	1-1
1.1.2 Performance	1-1
1.1.3 Environmental	1-1
1.1.4 Monitoring	1-1
1.1.5 Security	1-1
1.1.6 Available Base Models	1-2
1.2 NT24k Rackmount	1-3
1.2.1 Features and Benefits	1-3
1.2.2 NT24K Rackmount Specifications	1-4
1.2.3 NT24K Rackmount Dimensions	1-5
1.3 NT24k-DR16	1-6
1.3.1 Features and Benefits	1-6
1.3.2 NT24k-DR16 Specifications	1-7
1.3.3 NT24k-DR16 Dimensions	1-8
1.4 NT24k-DR24	1-9
1.4.1 Features and Benefits	1-9
1.4.2 NT24k-DR24 Specifications	1-10



1.4.3	NT24k-DR24 Dimensions	1-11
1.5	NT24k Views	1-12
1.5.1	NT24k Rackmount Unit Front View	1-12
1.5.2	NT24k Rackmount Unit View (Module Slots Identified)	1-12
1.5.3	NT24k-DR16 Front View	1-12
1.5.4	NT24k DR Unit View (Module Slots Identified)	1-13
1.6	LEDs	1-14
1.6.1	EIP Indicators	1-14
1.7	Transceiver Characteristics	1-15
1.7.1	NT24k-FX8 Module - 100 MB Fiber Transceiver Characteristics	1-15
1.7.2	NT24k-GX8 Module - Gigabit Fiber Transceiver Characteristics	1-15
1.7.3	NT24k-SFP-DM8 Module - SFP 100Base Fiber Transceiver Characteristics	1-15
1.7.4	NT24k-SFP-DM8 or NT24k-SFP8 Modules - SFP Gigabit Fiber Transceiver Characteristics	1-15
1.8	Ordering Guide	1-16
1.8.1	NT24K Rackmount	1-16
1.8.2	NT24K-DR16	1-16
1.8.3	NT24K-DR24	1-17
1.8.4	Port Modules	1-17
1.8.5	SFP Transceivers	1-18
Chapter 2 Hardware Installation		2-19
2.1	Unpacking	2-19
2.2	Module Installation	2-19
2.3	Mounting the NT24k	2-20
2.3.1	Rackmount Installation Instructions	2-20
2.3.2	DIN Rail Mounting Instructions	2-20
2.3.3	DIN-Rail Removal Instructions	2-21
2.4	Power Source	2-22
2.4.1	NT24k Rack Mount with DC Power Input Installed	2-22
2.4.2	NT24k with AC Power Supply Installed	2-23
2.5	Grounding the Unit	2-24
2.6	Configurable Alarm Contact	2-25
2.7	Connecting the Unit	2-26
2.8	Ethernet Cable	2-27
2.9	NTCD	2-28
2.10	USB Interface	2-29
2.10.1	USB Cable	2-29
2.10.2	Terminal	2-29
2.11	Cleaning	2-30
Chapter 3 Accessing the Web Software Interface		3-31
Service and Support Information		3-33
Limited Warranty		3-34

Preface

Disclaimer

Portions of this document are intended solely as an outline of methodologies to be followed during the maintenance and operation of N-Tron® Series NT24k® Modular equipment. It is not intended as a step-by-step guide or a complete set of all procedures necessary and sufficient to complete all operations.

While every effort has been made to ensure that this document is complete and accurate at the time of release, the information that it contains is subject to change. Red Lion Controls is not responsible for any additions to or alterations of the original document. Industrial networks vary widely in their configurations, topologies, and traffic conditions. This document is intended as a general guide only. It has not been tested for all possible applications, and it may not be complete or accurate for some situations.

Users of this document are urged to heed warnings and cautions summarized at the front of the document, such as electrical hazard warnings.

Compliance Information

It is recommended that the owner of this equipment determine and ensure conformance with any specific and applicable local regulations.

FCC Statement

This product complies with Part 15 of the FCC-A Rules.

Operation is subject to the following conditions:

1. This device may not cause harmful Interference
2. This device must accept any interference received, including interference that may cause undesired operation.

Note: This equipment has been tested and found to comply with the limits for a Class A digital device, pursuant to Part 15 of the FCC Rules. These limits are designed to provide reasonable protection against harmful interference in a residential installation. This equipment generates, uses, and can radiate radio frequency energy and, if not installed and used in accordance with the instructions, may cause harmful interference to radio communications. Operation of this device in a residential area is likely to cause harmful interference in which case the user will be required to correct the interference at his/her own expense.

Déclaration de conformité FCC

Ce produit est conforme à la partie 15 des règles de la FCC -A

Utilisation est soumise aux conditions suivantes:

1. Ce dispositif ne doit pas causer des interférences nuisibles
2. Cet appareil doit accepter toute interférence reçue, y compris les interférences qui peuvent causer un mauvais fonctionnement.



Note: Cet équipement a été testé et jugé conforme aux limites de la classe A des appareils numériques, conformément à la partie 15 des règles de la FCC. Ces limites sont conçues pour fournir une protection raisonnable contre les interférences nuisibles dans une installation résidentielle. Cet équipement génère, utilise et peut émettre de l'énergie radiofréquence et, si il n'est pas installé et utilisé conformément aux instructions, peut causer des interférences nuisibles aux communications radio. L'utilisation de cet appareil dans une zone résidentielle est susceptible de provoquer des interférences nuisibles, auquel cas l'utilisateur sera tenu de corriger les interférences à ses propres frais.

Industry Canada / Industrie Canada

This Class A digital apparatus meets all requirements of the Canadian Interference Causing Equipment Regulations. Operation is subject to the following two conditions; (1) this device may not cause harmful interference, and (2) this device must accept any interference received, including interference that may cause undesired operation.

Cet appareillage numérique de la classe A répond à toutes les exigences de l'interférence canadienne causant des règlements d'équipement. L'opération est sujette aux deux conditions suivantes: (1) ce dispositif peut ne pas causer l'interférence nocive, et (2) ce dispositif doit accepter n'importe quelle interférence reçue, y compris l'interférence qui peut causer l'opération peu désirée.

Environmental Impact Statement

Red Lion equipment contains no hazardous materials as defined by the United States Environmental Protection Agency (USEPA). Red Lion recommends that all failed product be returned to Red Lion for failure analysis and proper disposal.

Toxic Emissions

Red Lion equipment releases no toxic emissions.

Trademark and Registration Acknowledgments

Ethernet™ is a registered trademark of Xerox Corporation.

EtherNet/IP™ and CIP™ are registered trademarks of ODVA™.

All other company and product names are trademarks of their respective owners.

Release Notes and Document Updates

The hard copy and electronic media versions of this document are revised only at major releases and therefore, may not always contain the latest product information. As needed, Documentation Notes and or Product Bulletins may be provided between major releases to describe any new information or document changes.

The latest online version of this document and all product updates can be accessed through the Red Lion web site at <http://www.redlion.net>

Publication History

The following information lists the release history of this document.



ISSUE/REVISION	RELEASE DATE	CONTENT DESCRIPTION
Revised 2014-01-23	January 2014	Document Updates
Revised 2015-03-17	March 2015	Format Changes
Revised 2016-04-26	April 2016	Revised with updated ODVA requirements. Added safety updates.
Revised 2017-07-01	July 2017	Format changes and regulatory update

Related Documents

Visit the Technical Resources page on the Red Lion website at the following link to view available documents related to this product.

<http://www.redlion.net/documentation/red-lion-documentation>

Document Comments

Red Lion appreciates all comments that will help us to improve our documentation quality. The user can submit comments through the Red Lion Customer Service. Simply email us at customer.service@redlion.net.

Additional Product Information

Additional product information can be obtained by contacting the local sales representative or Red Lion through the contact numbers and/or e-mail addresses listed on the inside of the front cover.

Cautions and Warnings / Mises en Garde et Avertissements

Warnings apply to situations where personal injury or death may result.



Cautions apply to where reduced function or damage to equipment may result.

General Safety Cautions and Warnings / Précautions et Avertissements de Sécurité Générale





	<p>CAUTION: If the equipment is used in a manner not specified by Red Lion, the protection provided by the equipment may be impaired.</p> <p>ATTENTION: Si l'équipement est utilisé d'une manière non spécifiée par Red Lion, la protection fournie par l'équipement peut être compromise.</p>
-------------------------------------------------------------------------------------	--------------------------------------------------------------------------------------------------------------------------------------------------------------------------------------------------------------------------------------------------------------------------------------------------------------



	<p>CAUTION: Do not remove any of the covers. There are no serviceable parts within the unit. Do not substitute unauthorized parts or make unauthorized modifications to the unit.</p> <p>ATTENTION: Ne retirez aucun des couvercles. Il n'y a pas des pièces utilisables à l'intérieur de l'appareil. Ne pas remplacer les pièces non-autorisées ou effectuer des modifications non-autorisées de l'appareil.</p>
-------------------------------------------------------------------------------------	---------------------------------------------------------------------------------------------------------------------------------------------------------------------------------------------------------------------------------------------------------------------------------------------------------------------------------------------------------------------------------------------------------------------------------





	<p>CAUTION: Do not block any air vents on the unit. ATTENTION: N'obstruez pas les fentes d'aération de l'unité.</p>
	<p>CAUTION: Do not operate the equipment in a manner not specified by this manual. ATTENTION: Ne pas faire fonctionner l'équipement d'une manière non spécifiée par ce manuel.</p>
	<p>WARNING: Install only in accordance with Local and National Codes of authorities having jurisdiction. AVERTISSEMENT: Installer uniquement, conformément aux codes locaux et nationaux des autorités ayant compétence.</p>

Electrical Safety Warnings / Avertissements de Sécurité Électrique



	<p>WARNING - Never install or work on electrical equipment or cabling during periods of lightning activity. AVERTISSEMENT - Ne jamais installer ou travailler sur équipement électrique ou de câblage pendant les périodes d'activité de la foudre.</p>
	<p>CAUTION: Do not perform any services on the unit unless qualified to do so. Do not substitute unauthorized parts or make unauthorized modifications to the unit. ATTENTION: Ne pas effectuer de services sur l'appareil s'il n'est pas qualifié pour le faire. Ne pas substituer pièces non autorisées ou de modifications non autorisées de l'appareil.</p>
	<p>WARNING: Properly ground the unit before connecting anything else to the unit. Units not properly grounded may result in a safety risk and could be hazardous and may void the warranty. See the grounding technique section of this manual for proper ways to ground the unit. AVERTISSEMENT: L'unité doit être correctement mise à la terre avant tout raccordement à l'unité. Unités pas correctement mise à la terre peuvent causer un risque de sécurité et pourraient être dangereuses et peuvent annuler la garantie. Voir la section technique de mise à la terre dans ce mode d'emploi pour des moyens appropriés à la masse de l'appareil.</p>
	<p>WARNING: Device must be supplied by a Class 2 power source (except for POE models). AVERTISSEMENT: l'appareil doit être alimenté par une source d'alimentation de classe 2 (sauf pour les modèles POE).</p>



	<p>WARNING - Do not operate the unit with the top cover removed, as this could create a shock or fire hazard.</p> <p>AVERTISSEMENT - Ne pas faire fonctionner l'unité avec le couvercle retiré, ceci pourrait créer une décharge électrique ou un incendie.</p>
	<p>CAUTION: Observe proper DC Voltage polarity when installing power input cables. Reversing voltage polarity can cause permanent damage to the unit and voids the warranty.</p> <p>ATTENTION: Respectez la polarité correcte de tension DC lors de l'installation des câbles d'alimentation d'entrée. Inversion de polarité de tension peut causer des dommages permanents à l'appareil et annule la garantie.</p>

Environmental Safety Cautions and Warnings / Sécurité Environnementale Mises en Garde et Avertissements

	<p>WARNING: Do not operate the equipment in the presence of flammable gases or fumes. Operating electrical equipment in such an environment constitutes a definite safety hazard.</p> <p>AVERTISSEMENT : Ne pas utiliser le matériel en présence de gaz ou de vapeurs inflammables. L'utilisation de matériel électrique dans un tel environnement constitue un danger certain.</p>
	<p>WARNING: Disconnect the power and allow to cool 5 minutes before touching.</p> <p>AVERTISSEMENT: Déconnectez le câble d'alimentation et laissez refroidir 5 minutes avant de la toucher.</p>

Hazardous Location Warnings / Les Avertissements d'Emplacement Dangereux

	<p>CAUTION: This equipment is suitable for use in Class I, Division 2, Groups A, B, C, and D or non-hazardous locations only.</p> <p>ATTENTION: Cet appareil est adapté pour utilisation en Classe I, Division 2, Groupes A, B, C, D ou endroits non-dangereux seulement.</p>
	<p>WARNING: Explosion Hazard – Substitution of components may impair suitability for Class I, Division 2.</p> <p>AVERTISSEMENT - Risque d'explosion - La substitution de tout composant peut nuire à la conformité de Classe 1, Division 2.</p>
	<p>WARNING – Explosion Hazard – Do not connect or disconnect any connections while circuit is live unless area is known to be non-hazardous.</p> <p>AVERTISSEMENT - Risque d'explosion - Ne pas brancher ou débrancher les connexions lorsque le circuit est sous tension sauf si la zone est connue pour être non dangereux.</p>

	<p>WARNING: Exposure to some chemicals may degrade the sealing properties of materials used in the following devices: Relay U40.</p> <p>AVERTISSEMENT: L'exposition à certains produits chimiques peut dégrader les propriétés d'étanchéité des matériaux utilisés dans les dispositifs suivants: relais par U40.</p>
	<p>WARNING – Explosion Hazard – Do not replace the device unless power has been switched off or the area is known to be non-hazardous.</p> <p>AVERTISSEMENT – Risque d'explosion - Ne pas remplacer l'appareil à moins que l'alimentation a été coupée ou que la zone est connue pour être non-dangereuse.</p>
	<p>WARNING: Never connect or disconnect power when hazardous gases are present.</p> <p>AVERTISSEMENT: Ne jamais brancher ou débrancher l'alimentation lorsqu'en présence de gaz dangereux..</p>

Surrounding Air Temperature / Temperature Ambiante

NT24k-DC and NT24k-AC rackmount models: -40°C to 85°C

NT24k-DR16 and NT24k-DR24 models: -40°C to 75°C

Note: Use 105 °C or higher rated copper wire, (0.22NM) 2lb/in tightening torque for field installed conductors.

Remarque: Utilisez fil de cuivre classé 105 °C ou plus, (0.22Nm) 2 pouces/livres couple de serrage pour les connecteurs installés sur le terrain.

Laser Safety Warnings / Avertissements de Sécurité Laser

(Options: NTSFP-FX, NTSFP-FXE, NTSFP-SX, NTSFP-LX)

	<p>CAUTION: CLASS 1 LASER PRODUCT. Do not stare into the laser.</p> <p>ATTENTION: PRODUIT LASER CLASSE 1. Ne pas regarder dans le laser.</p>
-------------------------------------------------------------------------------------	------------------------------------------------------------------------------------------------------------------------------------------------------------

Regulatory Information

Product Safety

ANSI/ISA 12.12.01-2013 Class I and II, Div. 2 and Class III, Div. 1 and 2, Groups A, B, C and D Hazardous Locations

UL508 Industrial Control Equipment

CAN/CSA-C22.2 No. 213-M1987 Class I Div. 2 Hazardous Locations

CAN/CSA-C22.2 No. 14-M1987 Industrial Control Equipment

Emissions

FCC Title 47, Part 15, Radio Frequency Devices, Subpart B ANSI C63.4-2009

Industry Canada ICES-003, EN 55011; EN 61000-6-4, EN 61000-3-2, EN61000-3-3, EN 55032

Immunity

EN 55024, EN 61000-6-2; IEC 61000-4-2 (ESD); IEC 61000-4-3 (RFAM); IEC 61000-4-4 (EFT); IEC 61000-4-5 (SURGE); IEC 61000-4-6 (RFCM); IEC 61000-4-8 (PFMF); IEC 61000-4-11 (VDI)

Other

ABS Type Approval for Shipboard Applications; EMC Directive 2014/30/EU; LV Directive 2014/35/EU GOST-R, RoHS Compliant

KC Mark (Korea)

A 급 기기
(업무용 방송통신 기자재)

Class A device (Broadcasting and communication equipments for office work)

이 기기는 업무용(A급) 전자파 적합기기로서 판매자 또는 사용자는 이 점을 주의하시기 바라며, 가정 외 지역에서 사용하는 것을 목적으로 합니다.

This equipment is office use (Class A) electromagnetic wave suitability equipment and seller or user should take notice of it, and this equipment is to be used in the places except for home.



Chapter 1 Product Overview

1.1 NT24k® Modular Series Common Features

Red Lion's N-Tron® series NT24k® modular switches are available in rackmount or 35mm DIN-Rail mountable configurations with high density Gigabit ports. The NT24k offers a wide array of port configurations and power input options that include Fast Ethernet and Gigabit speeds in copper or fiber. The hot-swappable port modules are auto-detected and configured by the switch, adding new definition to plug-and-play performance. Housed in rugged hardened enclosures, the NT24k series features extended shock and vibration specifications (bulkhead mount required to meet requirements), wide operating temperature ratings and best-in-class technology.

1.1.1 Connectivity

The NT24k series switches feature hot-swappable connectivity modules. These modules are available in Fast or Gigabit Ethernet, and are optionally available with copper, fiber or SFP ports. The NT24k accepts up to three modules for a maximum of 24 Ethernet ports, and can be changed without removing power from the switch.

1.1.2 Performance

The NT24k line of managed switches provide uncompromising performance in harsh environments including network features like N-Ring™, VLAN, Quality of Service (QoS), port mirroring, IGMP and SNMP.

1.1.3 Environmental

The NT24k series of managed switches are available in rackmount or 35mm DIN-Rail mountable configurations with operating temperatures up to -40° to 85°C. With UL Class I, Division 2 listing and CE certifications, these switches are built to last in the most demanding environments.

1.1.4 Monitoring

The NT24k Series includes N-View monitoring technology. N-View combines switch based technology with a Windows based OPC server and client monitoring tool. When N-View is enabled, the switch periodically autocasts a small Ethernet packet containing switch and port statistics. The data is captured by the N-View OPC server software and can be displayed by the provided N-View client or third party OPC client application running in the same Windows environment. For more information, please reference the N-View Installation and User's Guide.

1.1.5 Security

The NT24k series provides a high level of security utilizing IEEE 802.1x port-based network access control with RADIUS remote server authentication and SNMPv3 communication protocol to ensure the safest connections.



1.1.6 Available Base Models

Part #	Total Ports	Mounting	Operating Temperature	10/100/1000 Copper	100 Fiber	Gig Fiber	SFP's	18-49 VDC Redundant Power Input*	90-264 VAC/90-300 VDC Power Input
NT24k-DR16-AC	16	35mm DIN-Rail	-40 °C to 75 °C	Up to 16	Up to 16	Up to 16	Up to 16	-	1
NT24k-DR16-DC	16	35 mm DIN-Rail	-40 °C to 75 °C	Up to 16	Up to 16	Up to 16	Up to 16	1	-
NT24k-DR24-AC	24	35 mm DIN-Rail	-40 °C to 75 °C	Up to 24	Up to 24	Up to 24	Up to 24	-	1
NT24k-DR24-DC	24	35 mm DIN-Rail	-40 °C to 75 °C	Up to 24	Up to 24	Up to 24	Up to 24	1	-
NT24k-AC1	24	19" Rackmount	-40 °C to 85 °C	Up to 24	Up to 24	Up to 24	Up to 24	-	1
NT24k-AC2	24	19" Rackmount	-40 °C to 85 °C	Up to 24	Up to 24	Up to 24	Up to 24	-	2
NT24k-AC1-DC1	24	19" Rackmount	-40 °C to 85 °C	Up to 24	Up to 24	Up to 24	Up to 24	1	1
NT24k-DC1	24	19" Rackmount	-40 °C to 85 °C	Up to 24	Up to 24	Up to 24	Up to 24	1	-
NT24k-DC2	24	19" Rackmount	-40 °C to 85 °C	Up to 24	Up to 24	Up to 24	Up to 24	2	-

* Each 18-49VDC power input option includes redundant (2) power connections.



1.2 NT24k Rackmount

The NT24k Rackmount Managed Industrial Ethernet Switch features connectivity for up to 24 Gigabit ports in a rugged 1U 19" rack mount enclosure. Designed to handle the most demanding environments, the NT24k supports up to two power inputs, extreme operating temperature range and three slots to accommodate mix-and-match port modules.

1.2.1 Features and Benefits

Features and Benefits

Supports up to three of the following port modules:

- 8-port 10/100/1000BaseT(X) module
- 8-port 100Base fiber module
- 8-port 1000Base fiber module
- 8-port Gigabit SFP module
- 8-port dual mode SFP module (100Base or 1000Base SFP transceivers)
- Easily transitions to Gigabit network requirements

-40°C to 85°C operating temperature

Dual power input options:

- Low Voltage: 18-49 VDC
- High Voltage: 90-264 VAC or 90-300 VDC

Onboard temperature sensor

ESD and surge protecting diodes on all copper ports

Auto-sensing 10/100/1000BaseT(X), duplex and MDIX

USB configuration port

Configurable alarm contact

Optional backup/restore configuration device

Fully managed features include:

- Jumbo frame support
- SNMP v1, v2, v3
- Web browser management
- Detailed ring map and fault location charting
- RSTP - 802.1d, 802.1w, 802.1D
- IGMP auto-configuration
- Trunking and port mirroring
- 802.1Q tag VLAN and port VLAN
- 802.1p QoS, port QoS and DSCP
- SNTP (Simple Network Time Protocol)
- IEEE 802.1x with RADIUS remote server authentication
- DHCP client
- N-Ring technology with ~30ms healing
- N-Link™ redundant ring technology
- N-View™ monitoring technology
- Ethernet/IP™
- CIP™ messaging



1.2.2 NT24K Rackmount Specifications

Mechanical				
Height	Width	Depth	Weight	Mount
1.9" (4.8 cm)	17.5" (44.5 cm)	12.7" (32.0 cm)	12.85 lbs (5.83 kg)	Rackmount 1U
Power Input				
Input Voltage	Steady Input Current	BTU/HR		
Low: 18-49 VDC High: 90 - 264 VAC or 90 - 300 VDC	Max: 2.26 A @ 24 VDC Max: 790 mA @ 120 VAC/450 mA @ 124 VDC	185 @ 24 VDC 365 @ 120 VAC/190 @ 124 VDC		
Environmental				
Operating Temperature	Storage Temperature	Operating Humidity	Operating Altitude	
-40°C to 85°C	-40°C to 85°C	5% to 95% (non condensing)	0 to 10,000 ft.	
Shock and Vibration				
Shock	Vibration	Note		
50g @ 10ms	30g, 10-200Hz, Triaxial	Unit must be bulkhead mounted to achieve these levels.		
Connectors				
10/100/1000BaseT(X): Up to 24 RJ45 ports				
100BaseFX: Up to 24 SC or ST fiber ports				
1000BaseSX/LX: Up to 24 SC fiber ports				
100BaseSX/LX SFP: Up to 24 LC fiber ports				
1000BaseGX SFP: Up to 24 LC fiber ports				
Recommended Minimum Wiring Clearance				
Back	4" (10.16 cm)			
Front	4" (10.16 cm)			

1.2.3 NT24K Rackmount Dimensions

Bottom View

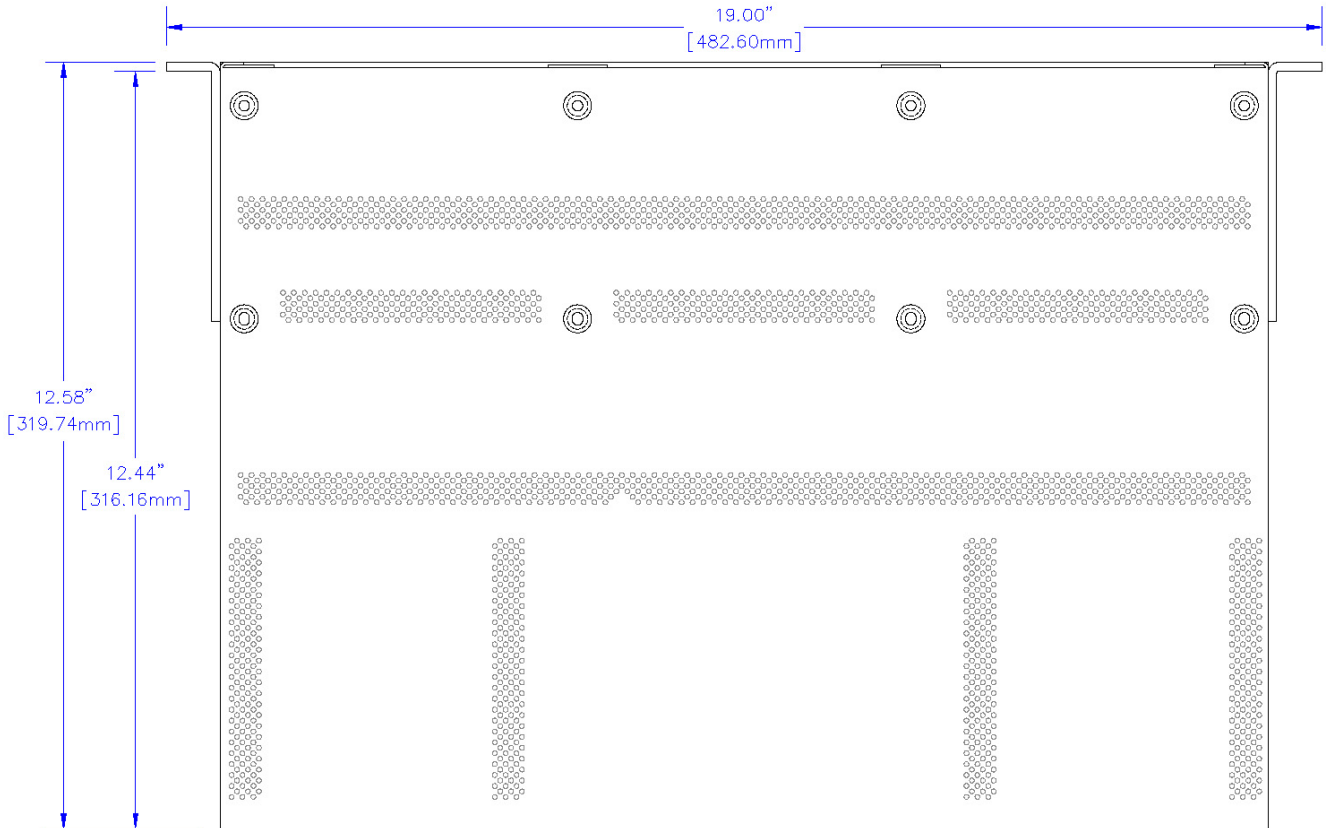

Front View

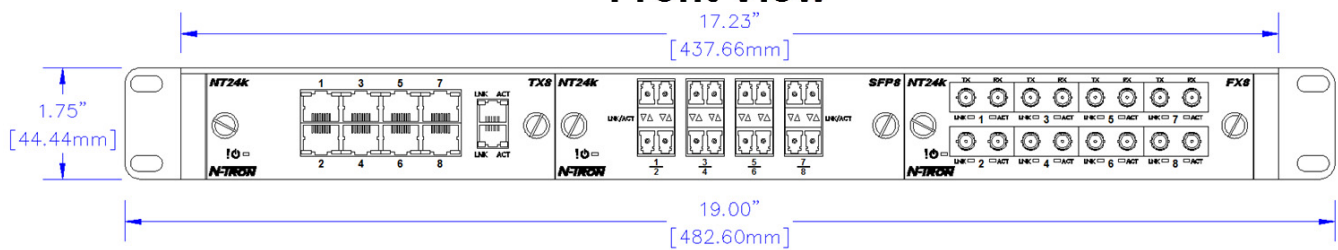

All specifications are subject to change. Consult the company website for more information.



1.3 NT24k-DR16

The NT24k-DR16 Managed Industrial Ethernet Switch features connectivity for up to 16 Gigabit ports in a rugged 35mm DIN-Rail enclosure.

1.3.1 Features and Benefits

Features and Benefits

Supports up to two of the following port modules:

- 8-port 10/100/1000BaseT(X) module
- 8-port 100Base fiber module
- 8-port 1000Base fiber module
- 8-port Gigabit SFP module
- 8-port dual mode SFP module (100Base or 1000Base SFP transceivers)

-40°C to 75°C operating temperature

Power input options:

- Low Voltage: 18-49 VDC
- High Voltage: 90-264 VAC or 90-300 VDC

Onboard temperature sensor

ESD and surge protecting diodes on all copper ports

Auto-sensing 10/100/1000BaseT(X), duplex and MDIX

USB configuration port

Configurable alarm contact

Optional backup/restore configuration device

Fully managed features include:

- Jumbo frame support
- SNMP v1, v2, v3
- Web browser management
- Detailed ring map and fault location charting
- RSTP - 802.1d, 802.1w, 802.1D
- IGMP auto-configuration
- Trunking and port mirroring
- 802.1Q tag VLAN and port VLAN
- 802.1p QoS, port QoS and DSCP
- SNTP (Simple Network Time Protocol)
- IEEE 802.1x. with RADIUS remote server authentication
- DHCP client
- N-Ring technology with ~30ms healing
- N-Link™ redundant ring technology
- N-View™ monitoring technology
- Ethernet/IP™
- CIP™ messaging



1.3.2 NT24k-DR16 Specifications

Mechanical				
Height	Width	Depth	Weight	Mount
5.97" (15.20 cm)	6.78" (17.22 cm)	4.59" (11.65 cm)	6.4 lbs (2.9 kg)	35mm DIN-Rail
Power Input				
Input Voltage	Steady Input Current	BTU/HR		
Low: 18-49 VDC High: 90 - 264 VAC or 90 - 300 VDC	Max: 1.52 A @ 24 VDC Max: 580 mA @ 120 VAC/300 mA @ 124 VDC	125 @ 24 VDC 268 @ 120 VAC/190 @ 124 VDC		
Environmental				
Operating Temperature	Storage Temperature	Operating Humidity	Operating Altitude	
-40°C to 75°C	-40°C to 85°C	5% to 95% (non condensing)	0 to 10,000 ft.	
Shock and Vibration				
Shock	Vibration	Note		
50g @ 10ms	30g, 10-200Hz, Triaxial	Unit must be bulkhead mounted to achieve these levels.		
Connectors				
10/100/1000BaseT:(X): Up to 16 RJ45 ports				
100BaseFX: Up to 16 SC or ST fiber ports				
1000BaseSX/LX: Up to 16 SC fiber ports				
100BaseSX/LX SFP: Up to 16 LC fiber ports				
1000BaseGX SFP: Up to 16 LC fiber ports				
Recommended Minimum Wiring Clearance				
Top	4" (10.16 cm)			
Front	4" (10.16 cm)			



1.3.3 NT24k-DR16 Dimensions

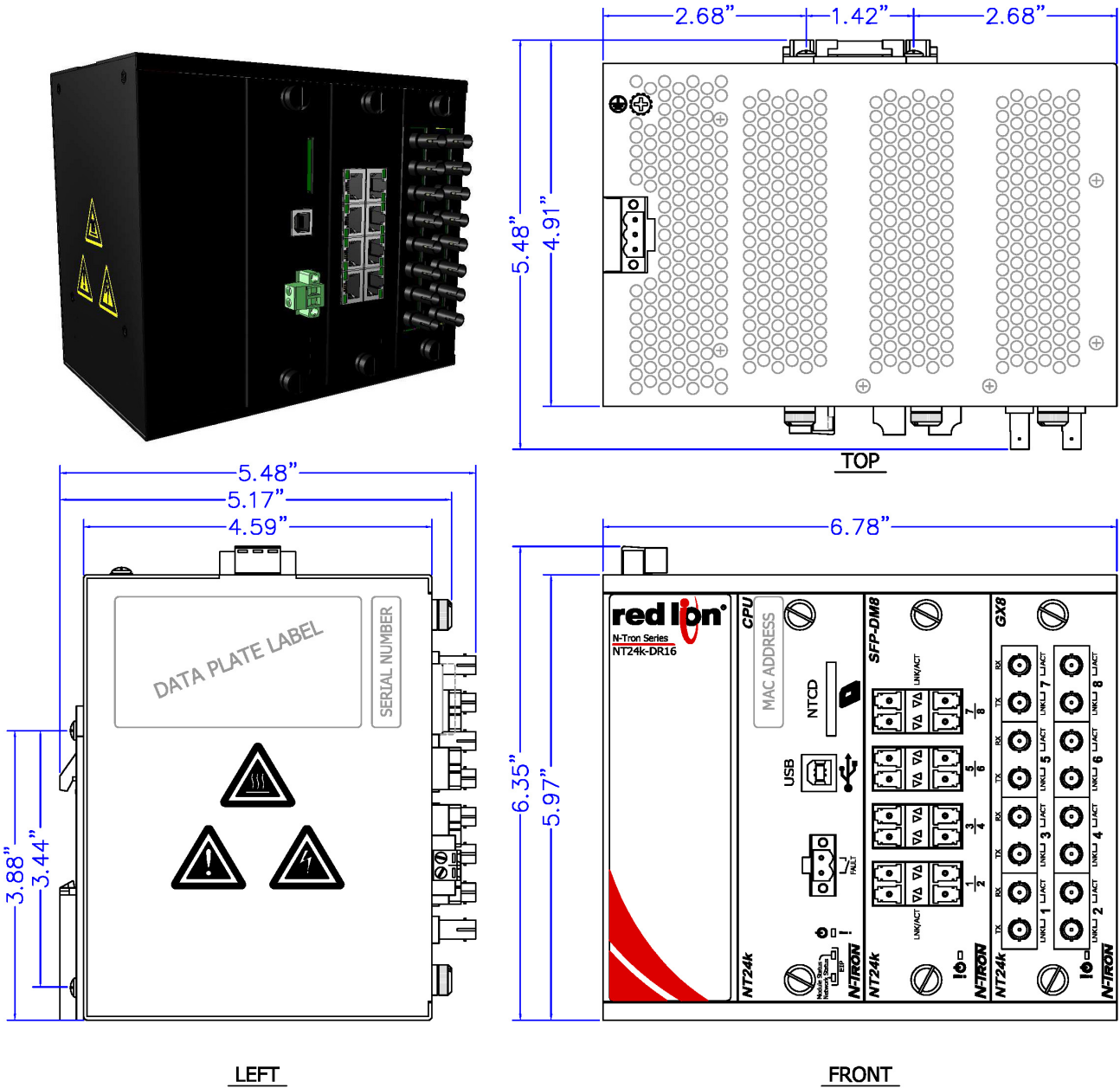

All specifications are subject to change. Consult the company website for more information.



1.4 NT24k-DR24

The NT24k-DR24 Managed Industrial Ethernet Switch features connectivity for up to 24 Gigabit ports in a rugged 35mm DIN-Rail enclosure.

1.4.1 Features and Benefits

Features and Benefits

Supports up to three of the following port modules:

- 8-port 10/100/1000BaseT(X) module
- 8-port 100Base fiber module
- 8-port 1000Base fiber module
- 8-port Gigabit SFP module
- 8-port dual mode SFP module (100Base or 1000Base SFP transceivers)

-40°C to 75°C operating temperature

Power input options:

- Low Voltage: 18-49 VDC
- High Voltage: 90-264 VAC or 90-300 VDC

Onboard temperature sensor

ESD and surge protecting diodes on all copper ports

Auto-sensing 10/100/1000BaseT(X), duplex and MDIX

USB configuration port

Configurable alarm contact

Optional backup/restore configuration device

Fully managed features include:

- Jumbo frame support
- SNMP v1, v2, v3
- Web browser management
- Detailed ring map and fault location charting
- RSTP - 802.1d, 802.1w, 802.1D
- IGMP auto-configuration
- Trunking and port mirroring
- 802.1Q tag VLAN and port VLAN
- 802.1p QoS, port QoS and DSCP
- SNTP (Simple Network Time Protocol)
- IEEE 802.1x with RADIUS remote server authentication
- DHCP client
- N-Ring technology with ~30ms healing
- N-Link™ redundant ring technology
- N-View™ monitoring technology
- Ethernet/IP™ CIP™ messaging



1.4.2 NT24k-DR24 Specifications

Mechanical				
Height	Width	Depth	Weight	Mount
5.97" (15.20 cm)	8.45" (21.46 cm)	4.59" (11.65 cm)	7.8 lbs (3.54 kg)	35mm DIN-Rail
Power Input				
Input Voltage	Steady Input Current	BTU/HR		
Low: 18-49 VDC High: 90 - 264 VAC or 90 - 300 VDC	Max: 2.14 A @ 24 VDC Max: 780 mA @ 120 VAC/430 mA @ 124 VDC	175 @ 24 VDC 360 @ 120 VAC/182 @ 124 VDC		
Environmental				
Operating Temperature	Storage Temperature	Operating Humidity	Operating Altitude	
-40°C to 75°C	-40°C to 85°C	5% to 95% (non condensing)	0 to 10,000 ft.	
Shock and Vibration				
Shock	Vibration	Note		
50g @ 10ms	30g, 10-200Hz, Triaxial	Unit must be bulkhead mounted to achieve these levels.		
Connectors				
10/100/1000BaseT:(X): Up to 24 RJ45 ports				
100BaseFX: Up to 24 SC or ST fiber ports				
1000BaseSX/LX: Up to 24 SC fiber ports				
100BaseSX/LX SFP: Up to 24 LC fiber ports				
1000BaseGX SFP: Up to 24 LC fiber ports				
Recommended Minimum Wiring Clearance				
Top	4" (10.16 cm)			
Front	4" (10.16 cm)			

1.4.3 NT24k-DR24 Dimensions

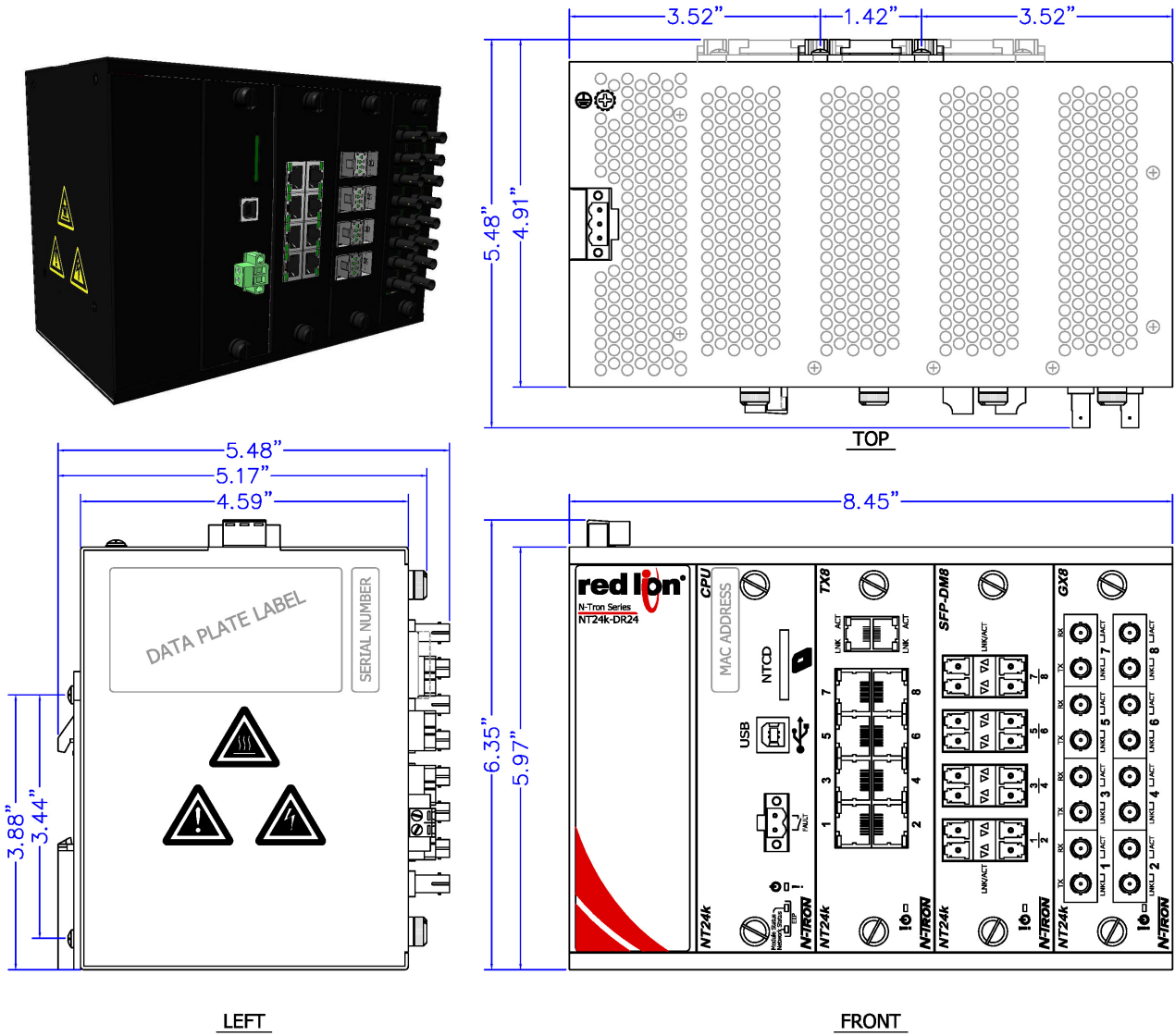

All specifications are subject to change. Consult the company website for more information.



1.5 NT24k Views

1.5.1 NT24k Rackmount Unit Front View



1.5.2 NT24k Rackmount Unit View (Module Slots Identified)

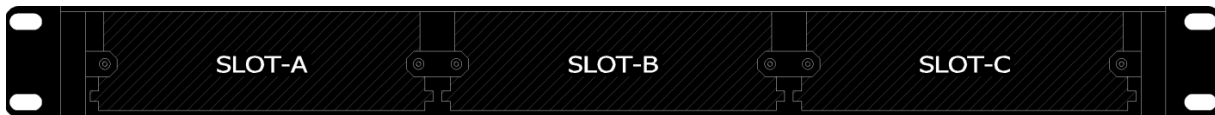

See section 1.8 for available module(s).

1.5.3 NT24k-DR16 Front View



1.5.4 NT24k DR Unit View (Module Slots Identified)

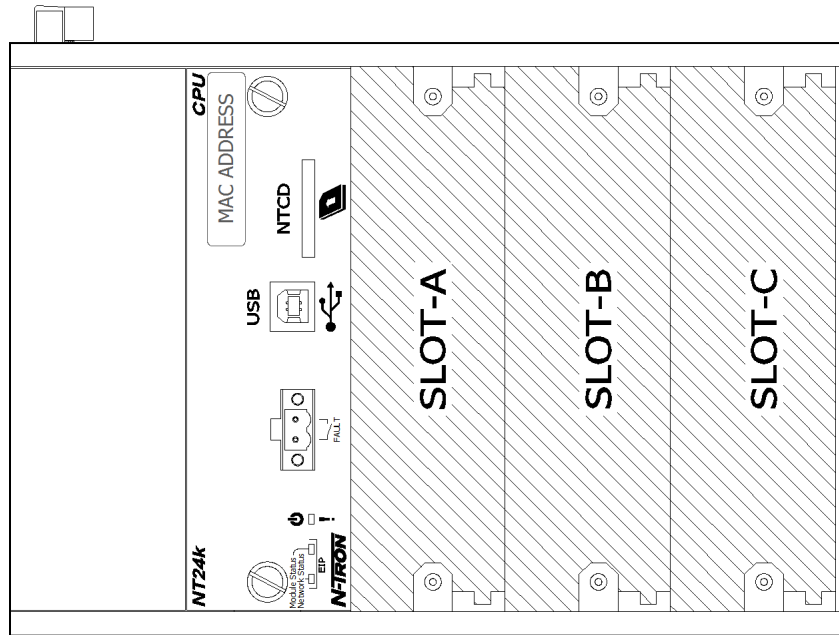

1.6 LEDs

The RJ45 data ports have two LEDs located on each connector. The left LED indicates link status and the right LED indicates activity.



The table below describes the operating modes:

LED	Color	Description
	Green	Power is On
	Red	Power is On and a fault condition exists
	Off	Power is Off
LNK	Green	10/100/1000 Mb Link between ports
	Off	No link between ports
ACT	Green	Data is active between ports. Activity light blink rate indicates activity, not necessarily the volume of activity
	Off	Data is inactive between ports

1.6.1 EIP Indicators

The EIP Indicators are located either on the back of the rackmount version, or on the front of the CPU module of the DIN-Rail versions of the switch. The Module Status indicator shows the status of the switch. The Network Status indicator shows the status of the network interface.

Module Status	
Indicator State	Description
Steady Off	The switch is not powered up
Steady Green	The switch is operating normally
Flashing Green	The switch has not been configured
Flashing Red	A recoverable minor fault has occurred
Steady Red	A non-recoverable major fault has occurred
Network Status	
Indicator State	Description
Steady Off	The switch is not powered up, or an IP address has not been configured
Flashing Green	An IP address is configured, but no connections have been established
Steady Green	A connection has been established
Flashing Red	A connection has timed out

1.7 Transceiver Characteristics

1.7.1 NT24k-FX8 Module - 100 MB Fiber Transceiver Characteristics

Fiber Length*	2 km	15 km	40 km	80 km
TX Power Min	-19 dBm	-15 dBm	-5 dBm	-5 dBm
RX Sensitivity Max	-31 dBm	-31 dBm	-34 dBm	-34 dBm
Wavelength	1310 nm	1310 nm	1310 nm	1550 nm

1.7.2 NT24k-GX8 Module - Gigabit Fiber Transceiver Characteristics

Fiber Length*	550 m @ 50/125 μ m 300 m @ 62.5/125 μ m	10 km	40 km	80 km
TX Power Min	-9.5 dBm	-9.5 dBm	-5 dBm	0 dBm
RX Sensitivity Max	-17 dBm	-20 dBm	-23 dBm	-24 dBm
Wavelength	850 nm	1310 nm	1310 nm	1550 nm
Laser Type	VCSEL	FP	DFB	DFB

1.7.3 NT24k-SFP-DM8 Module - SFP 100Base Fiber Transceiver Characteristics

Fiber Length*	2 km	10 km	40 km	80 km
TX Power Min	-19 dBm	-15 dBm	-5 dBm	-5 dBm
RX Sensitivity Max	-31 dBm	-34 dBm	-34 dBm	-34 dBm
Wavelength	1310 nm	1310 nm	1310 nm	1550 nm
Laser Type	FP	FP	FP	DFB

1.7.4 NT24k-SFP-DM8 or NT24k-SFP8 Modules - SFP Gigabit Fiber Transceiver Characteristics

Fiber Length*	550 m @ 50/125 μ m 275 m @ 62.5/125 μ m	10 km	40 km	80 km
TX Power Min	-9.5 dBm	-9.5 dBm	-2 dBm	0 dBm
RX Sensitivity Max	-17 dBm	-20 dBm	-22 dBm	-24 dBm
Wavelength	850 nm	1310 nm	1310 nm	1550 nm
Laser Type	VCSEL	FP	DFB	DFB

* Fiber Length distances represent typical performance. Link budgets should be evaluated based on specific application conditions.



1.8 Ordering Guide

1.8.1 NT24K Rackmount

Part Number	Description
NT24K-DC1	1U rackmount 3-slot modular Gigabit switch with one redundant 18-49 VDC power input
NT24K-DC2	1U rackmount 3-slot modular Gigabit switch with two redundant 18-49 VDC power inputs
NT24K-AC1	1U rackmount 3-slot modular Gigabit switch with one 90-264 VAC / 90-300 VDC power input
NT24K-AC2	1U rackmount 3-slot modular Gigabit switch with two 90-264 VAC / 90-300 VDC power inputs
NT24K AC1-DC1	1U rackmount 3-slot modular Gigabit switch with one each 90-264 VAC / 90-300 VDC and 18-49 VDC power inputs
NT24K-FP	Filler panel (required to fill vacant module slots)
NT24-PMK	Panel mount kit
NTCD-CFG	Configuration recovery device for use with NT24k series products
NTPC-AC-US	US Industrial High-Temp Power Cord Assembly for use with the 7026TX-AC and NT24k (Cord Length: 7 Ft., Gauge/Conductor: 18/3, Temp. Rating: 105°C, Plug: NEMA 5-15, Voltage Rating: 300V)
NTPS-24-3	35mm DIN-Rail power supply 3.0 Amp @ 24 VDC

1.8.2 NT24K-DR16

Part Number	Description
NT24K-DR16-DC	Managed Industrial Ethernet Switch; modular 35mm DIN-Rail design with 2 expansion slots; redundant 18-49 VDC power input
NT24K-DR16-AC	Managed Industrial Ethernet Switch; modular 35mm DIN-Rail design with 2 expansion slots; 90-264 VAC / 90-300 VDC power input
NT24K-FP	Filler panel (required to fill vacant module slots)
NT24K-DR-PMK	NT24K DR Panel mount kit
NTCD-CFG	Configuration recovery device for use with NT24k series products
NTPC-AC-US	US Industrial High-Temp Power Cord Assembly for use with the 7026TX-AC and NT24k (Cord Length: 7 Ft., Gauge/Conductor: 18/3, Temp. Rating: 105°C, Plug: NEMA 5-15, Voltage Rating: 300V)
NTPS-24-3	35mm DIN-Rail power supply 3.0 Amp @ 24 VDC

1.8.3 NT24K-DR24

Part Number	Description
NT24K-DR24-DC	Managed Industrial Ethernet Switch; modular 35mm DIN-Rail design with 3 expansion slots; redundant 18-49 VDC power input
NT24K-DR24-AC	Managed Industrial Ethernet Switch; modular 35mm DIN-Rail design with 3 expansion slots; 90-264 VAC / 90-300 VDC power input
NT24K-FP	Filler panel (required to fill vacant module slots)
NT24K-DR-PMK	NT24K DR Panel mount kit
NTCD-CFG	Configuration recovery device for use with NT24k series products
NTPC-AC-US	US Industrial High-Temp Power Cord Assembly for use with the 7026TX-AC and NT24k (Cord Length: 7 Ft., Gauge/Conductor: 18/3, Temp. Rating: 105°C, Plug: NEMA 5-15, Voltage Rating: 300V)
NTPS-24-3	35mm DIN-Rail power supply 3.0 Amp @ 24 VDC

1.8.4 Port Modules

Part Number	Description
NT24K-TX8	8-port 10/100/1000BaseT module
NT24K-FX8-XX	Slide-in module with 8 100BaseFX multimode fiber ports, 2 km (SC or ST)
NT24K-FXE8-XX-YY	Slide-in module with 8 100BaseFX singlemode fiber ports (SC or ST)
NT24K-GX8-SC	Slide-in module with 8 1000BaseFX multimode fiber ports, 550 m (SC)
NT24K-GXE8-SC-ZZ	Slide-in module with 8 1000BaseFX singlemode fiber ports (SC)
NT24K-SFP8	Slide-in module with 8 SFP expansion slots; supports 1000Base SFP transceivers*
NT24K-SFP-DM8	Slide-in module with 8 dual mode SFP expansion slots; supports 100Base or 1000Base SFP transceivers*
<p>Where: XX = ST or SC connector (ST not available on some GX modules); YY = 15, 40, or 80 for FX singlemode, blank for multimode; ZZ = 10, 40, or 80 for GX singlemode. *SFP transceivers sold separately.</p>	



1.8.5 SFP Transceivers

Part Number	Description	Maximum Capacity Per Switch	Module Required
NTSFP-FX	100 BaseFX multimode fiber SFP pluggable mini-GBIC transceiver (LC style connector, 2 km)	Up to 24	NT24k-SFP-DM8
NTSFP-FXE-YY	100BaseFX singlemode fiber SFP luggable mini-GBIC transceiver (LC style connector)	Up to 24	NT24k-SFP-DM8
NTSFP-TX	1000BaseT copper SFP pluggable mini-GBIC transceiver	Up to 16	NT24k-SFP8 or NT24k-SFP-DM8
NTSFP-SX	1000BaseSX multimode fiber SFP pluggable mini-GBIC transceiver	Up to 24	NT24k-SFP8 or NT24k-SFP-DM8
NTSFP-LX-ZZ	1000BaseLX singlemode fiber SFP pluggable mini-GBIC transceiver	Up to 24	NT24k-SFP8 or NT24k-SFP-DM8
Where: XX = ST or SC connector (ST not available on some GX modules); YY = 15, 40, or 80 for FX singlemode, blank for multimode; ZZ = 10, 40, or 80 for GX singlemode. *SFP transceivers sold separately.			



Chapter 2 Hardware Installation

2.1 Unpacking

Remove all the equipment from the packaging and store the packaging in a safe place. File any damage claims with the carrier.

Make certain the NT24k[®] Ethernet Switch package contains the following items:

1. NT24k Switch
2. Product CD

2.2 Module Installation

Technicians performing the following steps should wear proper anti-static equipment to protect the circuit boards. Before removing the module from the ESD bag, touch a known grounded piece of metal to discharge any possible static electricity from the body.

1. Remove the faceplate from the slot in which the module will be inserted by turning the thumb screws counter clockwise.
2. Remove the module from the anti-static bag and insert into the slot aligning the board with the guide rails on either side. The module should slide smoothly into the slot.
3. Press the module firmly in place until the faceplate is flush against the front of the enclosure.
4. Align the threads of the thumb screws with the threads in the enclosure and screw them down until they are finger tight.

Ensure that all empty slots are covered with a faceplate to meet both emissions and safety requirements.



2.3 Mounting the NT24k

2.3.1 Rackmount Installation Instructions

The NT24k Rackmount unit comes configured with standard rack mount brackets which may be used to mount our products to standard 19" racks. As an alternative, Red Lion offers its NT24k Panel Mount Assembly (P/N: NT24k-PMK) used to securely mount the NT24k products to a panel or other flat surface.

A clearance of one inch should be observed on the sides, back, top and bottom to allow proper ventilation. Also a cable bend radius of 4 inches should be observed for the front and back of the unit.

2.3.2 DIN Rail Mounting Instructions

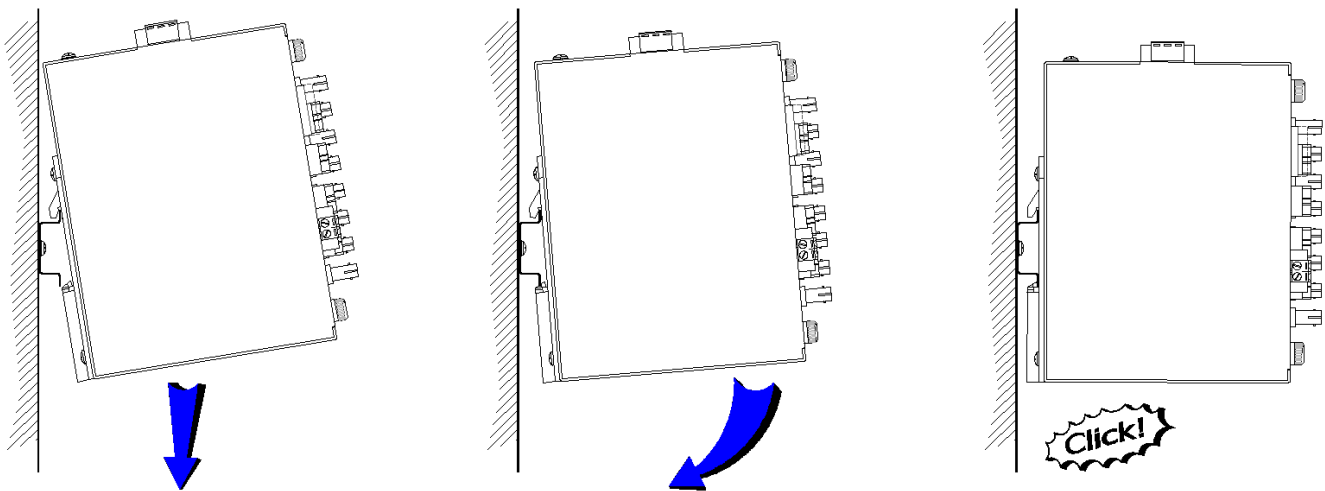

Install the switch to standard 35mm DIN-Rail as shown in the diagram above.

1. First, hook the top of the 35mm DIN-Rail clip on the back of the switch to the rail.
2. Then, gently rotate the front of the switch downward, towards the panel.
3. Push the bottom of the switch towards the rail until it locks into place.
4. Apply upward force to verify the switch is securely installed.
5. Connect any communications cables to the switch.
6. Install the power and ground wires.
7. Apply power to the power supply.

2.3.3 DIN-Rail Removal Instructions

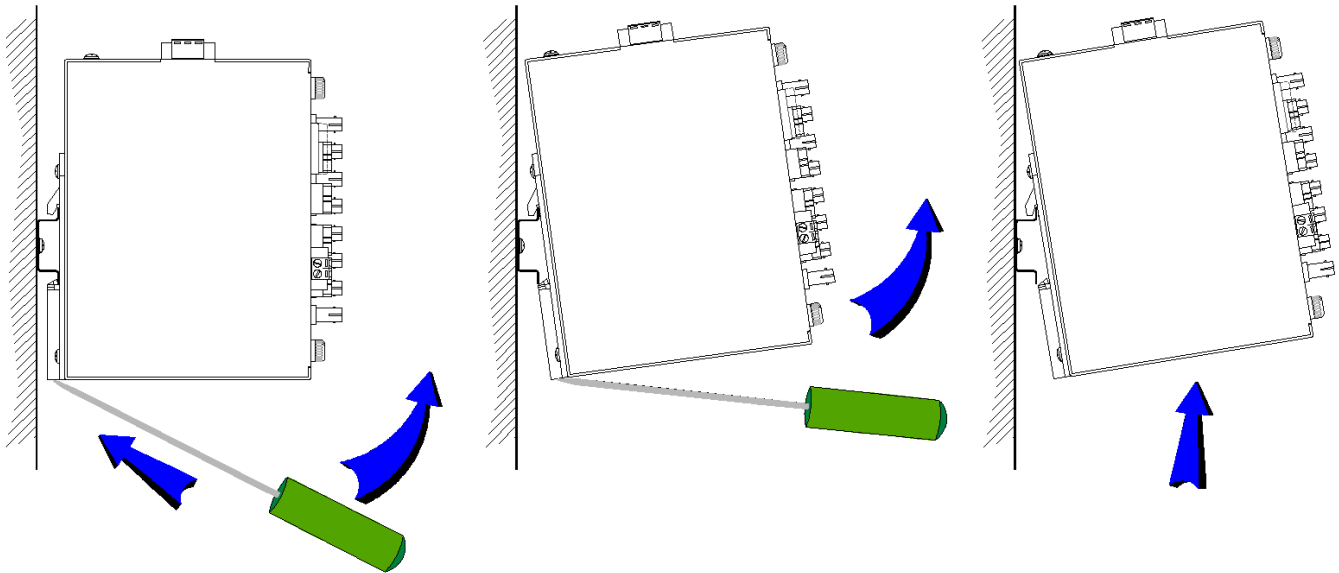

Remove the switch from standard 35mm DIN-Rail as shown in the diagram above.

1. Ensure power from the power source is off.
2. Disconnect power and ground wires.
3. Disconnect any communications cables from the unit.
4. Insert a standard flat/slotted screwdriver into the slot provided on the DIN-Rail clip.
5. Using the base of the switch as a pivot point, apply upward force on the screwdriver to release the DIN-Rail clip.
6. With the DIN-Rail clip latching mechanism released, continue to rotate the switch upward and away from the panel.
7. Once the switch has been rotated upward, remove the screwdriver.
8. Carefully lift the switch upward and away from the DIN-Rail and panel.

2.4 Power Source

The NT24k-DR16 and NT24k-DR24 series operate with one power supply, either AC or DC.

The Rack Mount NT24k can be ordered with one or two power input options.

Each power supply can be AC or DC. Each low voltage DC Power supply includes redundancy (two DC supplies).

The NT24k-AC1-DC1 model shown below comes with a high voltage power input on the left (90-264VAC / 90-300VDC) and a redundant 18-49VDC power input on the right.

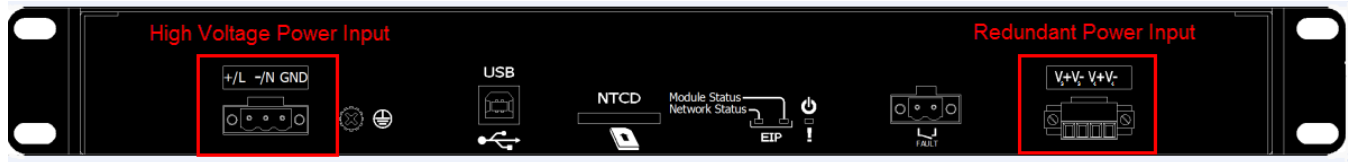

Note: LEDs are described in detail in [section 1.6](#)

2.4.1 NT24k Rack Mount with DC Power Input Installed

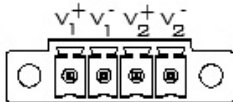
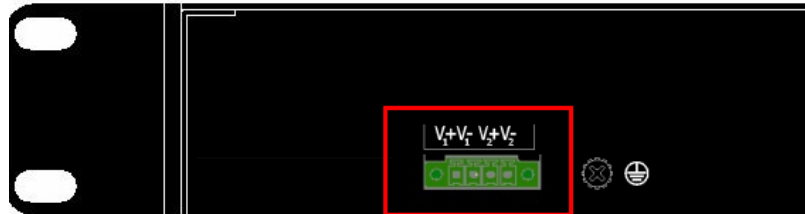

1. Unscrew and remove the DC voltage input plug from the power input header.
2. Install the DC power cables into the plug (observing polarity).
3. Plug the voltage input plug back into the power input header.
4. Tightening torque for the terminal block power plug is 0.5 Nm/0.368 lb/ft.
5. Verify that the power LED is on.

Note: When a DC power supply is installed, only one power supply must be connected to power for minimal operation. For redundant power operation, V1 and V2 inputs must be connected to separate DC voltage sources. This device will draw current from both sources simultaneously. Use 16-28 gauge wire when connecting to the power supply.

Recommended 24 VDC power supply, similar to Red Lion's P/N NTPS-24-3.

2.4.2 NT24k with AC Power Supply Installed

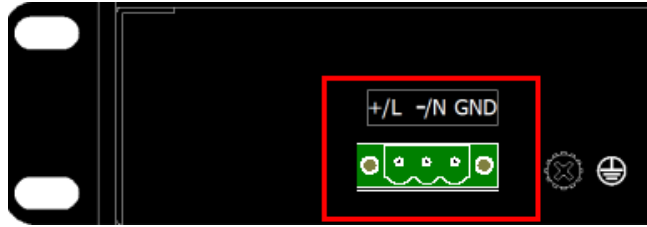

1. Unscrew and remove the AC voltage input plug from the power input header.
2. Install the AC power cables into the plug (observing polarity).
3. Plug the voltage input plug back into the power input header.
4. Tightening torque for the terminal block power plug is 0.5 Nm/0.368 lb/ft.
5. Verify that the power LED is on.

Note: When an AC power supply is installed (i.e. the -AC option), use 12-24 gauge wire when connecting to the power supply.

2.5 Grounding the Unit

The grounding of any control system is an integral part of the design. The optimum noise immunity and emissions are obtained when the NT24k chassis is connected to earth ground via a 14-18 gauge drain wire. The NT24k units provide a ground lug (see illustration) that is used to provide a safe grounding path of the device. For the NT24k-AC power supplies, the chassis may also be connected to earth ground using the input power plug labeled “GND.”

Note: The NT24k power input (V-) pins are isolated from chassis ground. Do not attempt to ground the switch to earth ground via the power input pins (V-).

Remarque: La NT24k puissance d'entrée (V-) broches sont isolés de la masse du châssis. Ne pas essayer pour mettre le commutateur à la terre via les broches d'entrée d'alimentation (V-).

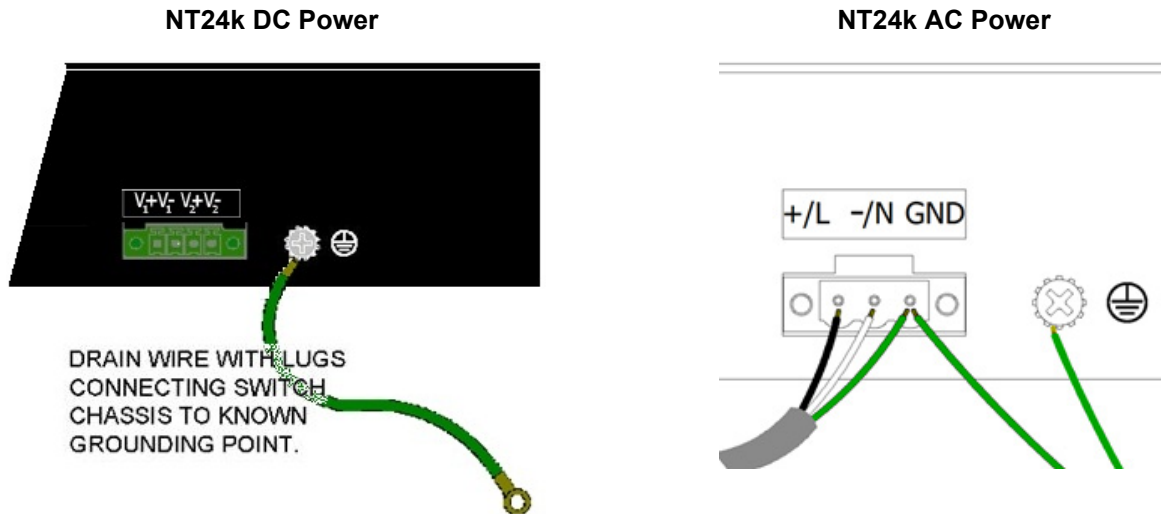

For the Din-Rail models, see the illustration below for grounding:

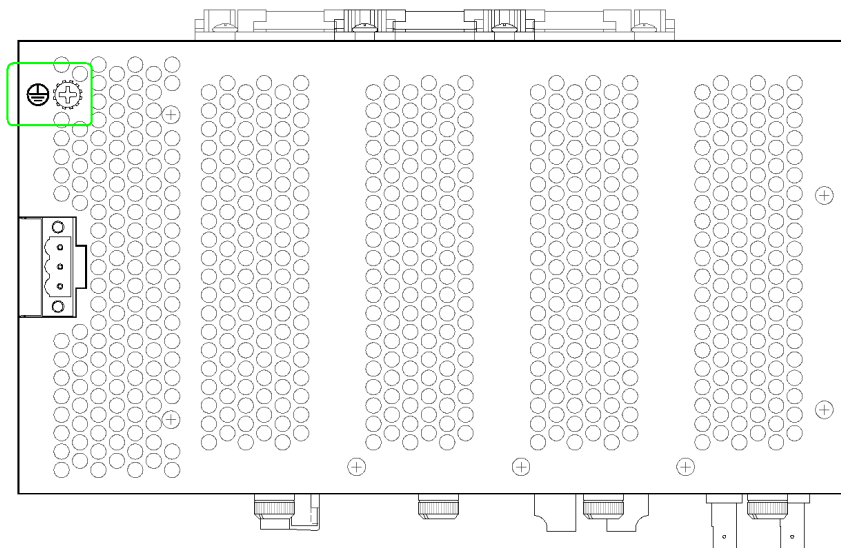

2.6 Configurable Alarm Contact

The alarm contact located on the back of the NT24k rack mount unit or on the front of the NT24k-DR16 and NT24k-DR24 models, can be used to control an external warning device based on an event. The current carrying capacity is 1A at 24VDC. It is normally open and the relay closes when a fault condition occurs, though this can be reversed via configuration. These pins can be used to connect an external warning device such as a light in order to provide an external alarm. The conditions for generating a fault condition (closing the relay) can be configured through software.

Refer to the NT24k Software User's Guide for more information.

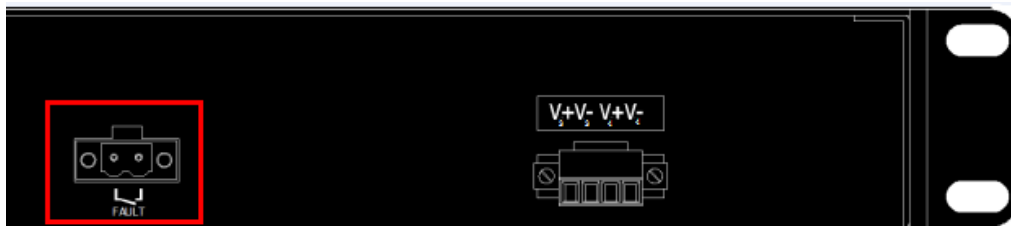

2.7 Connecting the Unit

For 10/100/1000/T(x) ports, plug a Category 5E twisted pair cable into the RJ45 connector. Connect the other end to the far end station. Verify that the LNK LEDs are ON once the connection has been completed. To connect any port to another device, use a standard CAT5E straight through or crossover cable with a minimum length of one meter and a maximum length of 100 meters.

Red Lion recommends the use of pre-manufactured CAT5E cables to ensure the best performance. If this is not an option and users must terminate their own ends on the CAT5E cables; one of the two color coded standards shown to the right should be utilized. If a user does not follow one of these standards then the performance and maximum cable distance will be reduced significantly, and may prevent the switch from establishing a link.

For FX/FXE/GX/GXE units, remove the dust cap from the fiber optic connectors and connect the fiber optic cables. The TX port on the FX/FXE/GX/GXE models should be connected to the RX port of the far end station. The RX port on the FX/FXE/GX/GXE versions should be connected to the TX port of the far end station.

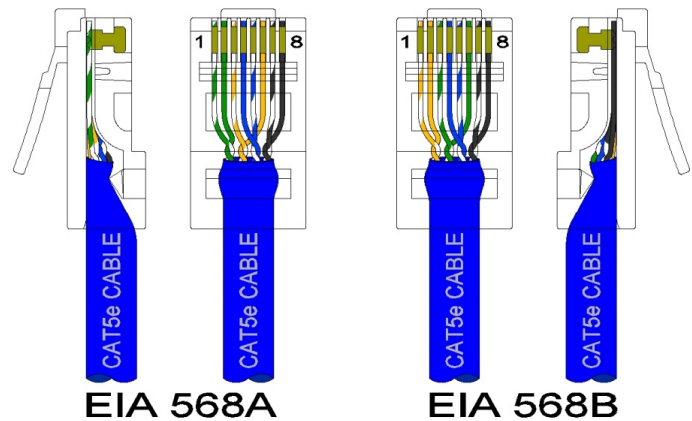

WARNING – Creating a network loop without employing a network path protocol such as N-Ring, N-Link, or RSTP is an illegal operation that can create a network storm which will crash the network.

Avertissement - La création d'un réseau sans boucle employant un chemin réseau protocole tels que N-Ring, N-Link, ou RSTP est une opération illégale que peut créer une tempête du réseau qui va planter le réseau.

2.8 Ethernet Cable

If you are connecting to the unit via the copper port, you will need a straight or crossover cable with two 8-pin RJ45 connectors on each end.

To visually confirm that Ethernet cabling was done properly, check the LED indication on the Ethernet port of the unit. The link LED should be on when the correct cable is used.

Note: A shielded cable is required to fully meet EMC standards.

When using shielded cables, it is generally recommended to only connect the shield at one end to prevent ground loops and interference with low level signals (i.e. thermocouples, RTD, etc.). CAT5e cables manufactured to EIA-568A or 568B specifications are required for use with Red Lion series switches.

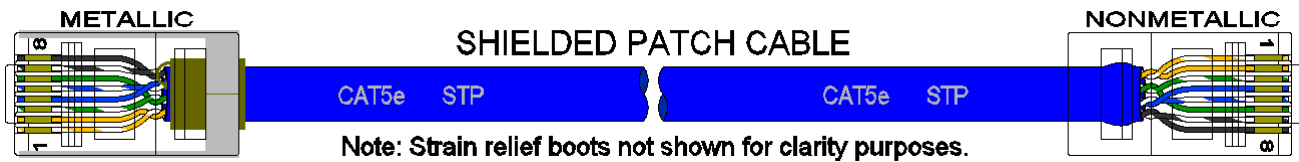

In the event all CAT5e patch cables are short (i.e. All Ethernet devices are located in the same local cabinet and/or referenced to the same earth ground), it is permissible to use fully shielded cables terminated to chassis ground at both ends in systems avoid low level analog signals.

RJ45 Connector Crimp Specifications

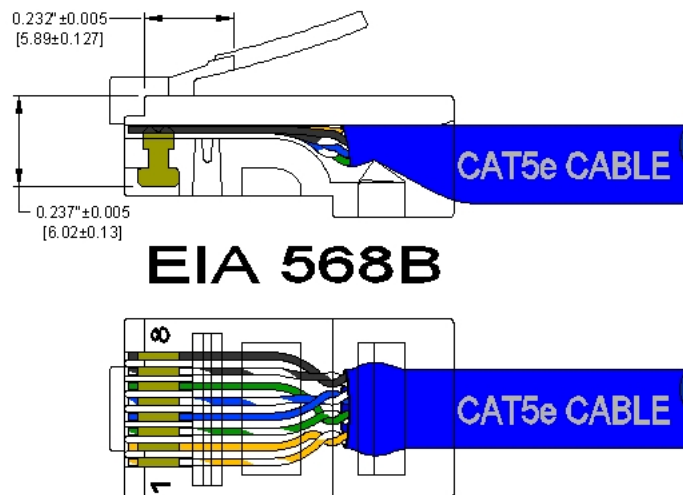

2.9 NTCD

NTCD-CFG Configuration Device



Ideal for saving, or restoring switch configuration parameters quickly without the need for a computer or software. One configuration device per switch is recommended.

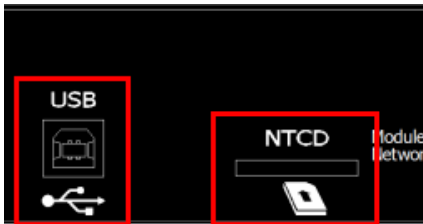

The USB configuration slot is located on the back of the NT24k rackmount models and on the front of the NT24k-DR16 and NT24k-DR24 models.

The unit could be configured with multiple power supply configurations.



WARNING – Explosion Hazard – Do not connect or disconnect any connections while circuit is live unless area is known to be non-hazardous. Connection or disconnection in an explosive atmosphere could result in an explosion.

AVERTISSEMENT - Risque d'explosion - Ne pas brancher ou débrancher les connexions lorsque le circuit est sous tension sauf si la zone est connue pour être non dangereux. Connexion ou la déconnexion dans une atmosphère explosive pourrait entraîner une explosion.

2.10 USB Interface

The NT24k switches provide a USB interface accessed via the USB connector labeled as “USB” on the back of the NT24k rackmount models and the front of the NT24k-DR16 and NT24k-DR24 models. The USB connection is used to access the Command Line Interpreter (CLI) or PPP (Point-to-Point Protocol).



2.10.1 USB Cable

Connect the USB port of your PC and the Switch using a standard USB cable. A cable with a Type A connector for the PC end, and a Type B connector for the switch end must be used.

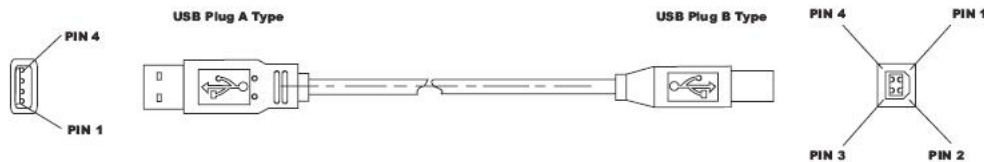

Standard USB cables are readily available from a variety of computer stores.

2.10.2 Terminal

The following configuration should be used in HyperTerminal:

Port Settings: 115200
 Data Bits: 8
 Parity: None
 Stop Bits: 1
 Flow Control: None



WARNING – Explosion Hazard – The USB connection is for temporary connection only. Do not use, connect, or disconnect unless the area is known to be non-hazardous. Connection or disconnection in an explosive atmosphere could result in an explosion.

AVERTISSEMENT - Risque d'explosion - La connexion USB est pour la connexion temporaire seulement. Ne pas utiliser, connecter ou déconnecter sauf si la zone est connue pour être non dangereuse. Connexion ou la déconnexion dans une atmosphère explosive pourrait entraîner une explosion.

2.11 Cleaning

Clean only with a damp cloth. Excess moisture or harsh chemicals can cause damage to the unit.



Chapter 3 Accessing the Web Software Interface

1. Launch a web browser and enter the IP address of the device into the address bar.
The DHCP Client is enabled by default with the 192.168.1.201 as the fallback address.
2. The following login screen will appear:

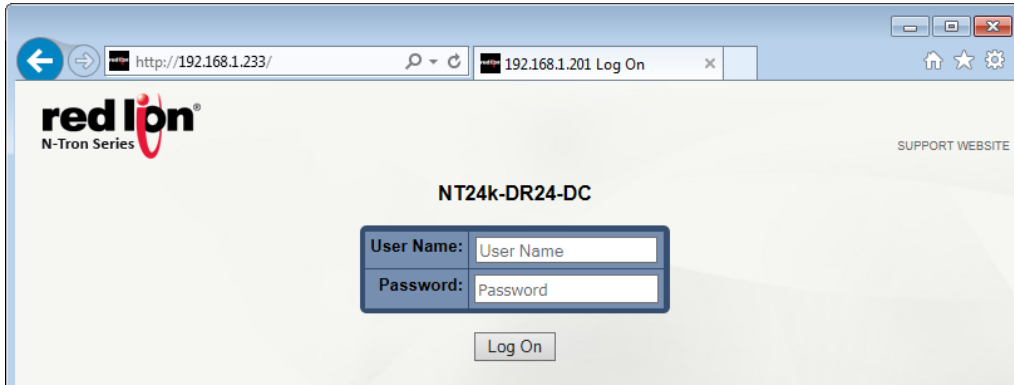

3. For the User Name, enter: **admin** (all lowercase)
4. For the password, enter: **admin** (all lowercase).

Note: For security purposes, it is recommended that the password be changed according to your internal policies. Login credentials can be changed on the **User Management** page.

5. Upon successfully logging in, depending on the unit used, a screen similar to the one below will appear:

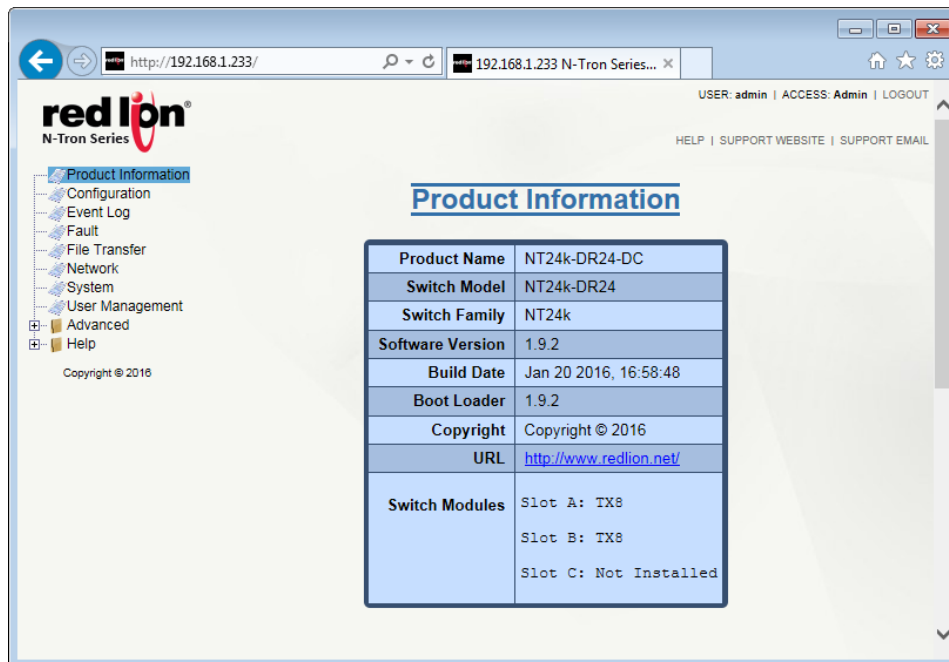

Please consult the NT24K[®] Software Manual for configuration options.



Service and Support Information

Service Information

We sincerely hope that you never experience a problem with any of our products. If you do need service, call Red Lion at 1-877-432-9908 for Technical Support. A trained specialist will help you determine the source of the problem. Many problems are easily resolved with a single phone call. If it is necessary to return a unit to us, an SO (Service Order) can be obtained on the [Red Lion website](#).

Red Lion tracks the flow of returned material with our SO system to ensure speedy service. You must include this SO number on the outside of the box so that your return can be processed immediately.

Be sure to have your original purchase order number and date purchased available.

We suggest that you give us a repair purchase order number in case the repair is not covered under our warranty. You will not be billed if the repair is covered under warranty.

Please supply us with as many details about the problem as you can. The information you supply will be written on the SO form and supplied to the repair department before your unit arrives. This helps us to provide you with the best service, in the fastest manner. Repairs are completed as soon as possible. If you need a quicker turnaround, ship the unit to us by air freight. We give priority service to equipment that arrives by overnight delivery.

We apologize for any inconvenience that the need for repair may cause you. We hope that our rapid service meets your needs. If you have any suggestions to help us improve our service, please give us a call. We appreciate your ideas and will respond to them.

For Your Convenience:

Please fill in the following and keep this manual with your **RED LION** system for future reference:

P.O. #: _____ Date Purchased: _____

Purchased From: _____ Serial Number: _____

MAC Address: _____

Product Support

Technical Support:

Inside US: +1 (877) 432-9908

Outside US: +1 (717) 767-6511

Fax: +1 (717) 764-0839

E-mail: support@redlion.net

Hours: 8:00 am to 6:00 pm EST

Red Lion Controls

20 Willow Springs Circle

York, PA 17406

Website: www.redlion.net



Limited Warranty

a) Red Lion Controls Inc., (the "Company") warrants that all Products shall be free from defects in material and workmanship under normal use for the period of time provided in "Statement of Warranty Periods" (available at www.redlion.net) current at the time of shipment of the Products (the "Warranty Period"). **EXCEPT FOR THE ABOVE-STATED WARRANTY, COMPANY MAKES NO WARRANTY WHATSOEVER WITH RESPECT TO THE PRODUCTS, INCLUDING ANY (A) WARRANTY OF MERCHANTABILITY; (B) WARRANTY OF FITNESS FOR A PARTICULAR PURPOSE; OR (C) WARRANTY AGAINST INFRINGEMENT OF INTELLECTUAL PROPERTY RIGHTS OF A THIRD PARTY; WHETHER EXPRESS OR IMPLIED BY LAW, COURSE OF DEALING, COURSE OF PERFORMANCE, USAGE OF TRADE OR OTHERWISE.** Customer shall be responsible for determining that a Product is suitable for Customer's use and that such use complies with any applicable local, state or federal law.

(b) The Company shall not be liable for a breach of the warranty set forth in paragraph (a) if (i) the defect is a result of Customer's failure to store, install, commission or maintain the Product according to specifications; (ii) Customer alters or repairs such Product without the prior written consent of Company.

(c) Subject to paragraph (b), with respect to any such Product during the Warranty Period, Company shall, in its sole discretion, either (i) repair or replace the Product; or (ii) credit or refund the price of Product provided that, if Company so requests, Customer shall, at Company's expense, return such Product to Company.

(d) THE REMEDIES SET FORTH IN PARAGRAPH (c) SHALL BE THE CUSTOMER'S SOLE AND EXCLUSIVE REMEDY AND COMPANY'S ENTIRE LIABILITY FOR ANY BREACH OF THE LIMITED WARRANTY SET FORTH IN PARAGRAPH (a).

