

TB-4M8M-3N2-3

Junction Box - Actuator/Sensor, 4-port – M8, 3 pole I/O port with cable homerun

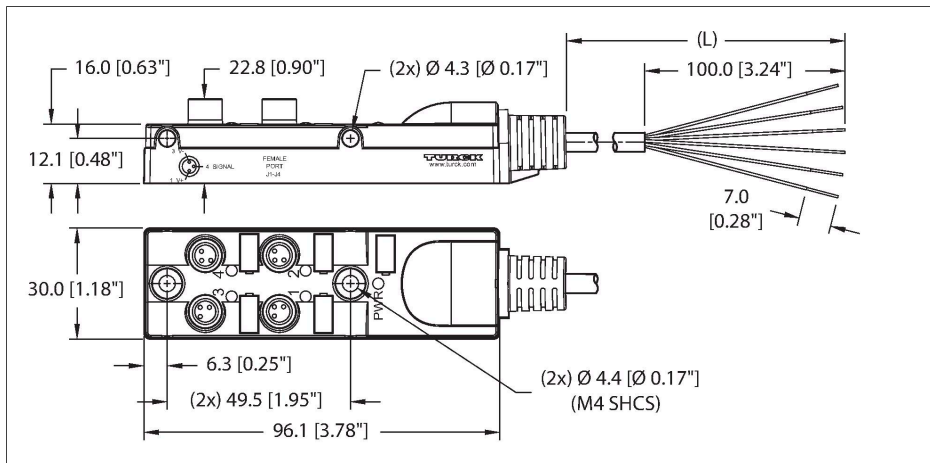

Features



- Housing material: Nylon
- Housing color: Black
- Fully encapsulated
- Protection class: IP67, IP68, IP69, IP69K; NEMA 1, 3, 4, 6P, 12
- RoHS compliant
- CE compliant
- LED (NPN circuit)
- I/O port: 3-pin
- General Purpose Cable
- Black PVC jacket, shielded, 6X24 AWG
- -40 Cold Bend Rating
- Flame Ratings: UL1061, CSA FT1
- Cable length: 3 m

Cable cross section

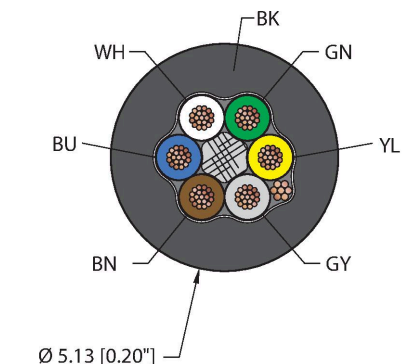

Technical data

Type	TB-4M8M-3N2-3
ID no.	UX19224
Distributed I/O	Junction box, 4, with integral homerun cable
Housing	Plastic, PA 6 GF30, Black
Display operating voltage	LED, green
Display switching state	LED, yellow
Switching function	NPN
I/O Port	M8 x 1, Female
Design specification	Acc. to IEC 61076-2-104
Number of Pins	3
Contacts	Brass, CuZn, Gold-plated
Contact carriers	Plastic, PA 4.6 GF30, Black
Connector seal	O-ring, Plastic, FKM/FPM
Housing material/finish	Brass, CuZn, Nickel-plated
Mechanical life	> 100 Mating cycles
Pollution degree	3
Protection class (When coupled)	IP67, IP68, IP69, IP69K NEMA: 1, 3, 4, 6P, 12
Homerun connector	Side exit
Cable data	
Cable ID	RF50845
Total number of conductors	6

TB-4M8M-3N2-3 | 06/09/2021 14-33 | technical changes reserved

Technical data

Cable diameter	Ø 5.13 mm
Cable length (L)	3 m (+50mm or 4% of length/-0.0, Whichever is greater)
Cable jacket	PVC, Black
Shield	Aluminum/polyester (IN)
Cable drain	26 AWG, TC (Tinned Copper)
Conductor diameter	0.044 "
Conductor material	TC (tinned copper)
Conductor insulation material	PVC
Conductor size	6 x 24 AWG [Similar to 0.25 mm ²]
Number of strands x O.D.	19 x 36 AWG
Conductor colors	GN, YL, GY, BN, BU, WH
Electrical properties at +20 °C	
Rated voltage	30 VDC
Current	2 A per signal contact, total current 6 A
Mechanical and chemical properties	
Bending radius (static)	≥ 5 x Ø
Bending radius (dynamic)	≥ 15 x Ø
Cold bend rating	-40 °C
Ambient temperature range (static)	-40 °C...+85 °C
Ambient temperature range (dynamic)	-40 °C...+85 °C
Temperature range (installation)	-20 °C...+85 °C
Approval	
Approvals	CE RoHS
Note	
<p>- Flex ratings may be reduced if used in extreme temperatures, exposure to certain chemicals, operating above the rated cycle speed, or operating below the rated cable bend radius.</p> <p>- We reserve the right to make technical alterations without prior notice.</p>	

Contact assignment

I/O Connector



Scope of delivery

Device	Quantity	Description
Junction boxes	1	Passive actuator/sensor junction box
PSGK-MC	2	Closure caps for M8 female connectors
KS5/10	5	Labels

Accessories

Ident-No.	Part Number	Description
U5312-2	RKC 8.6T-5	Connection cordset, female, M12, 8-pin, straight, 5m * (homerun)
U5306-20	WKC 8.6T-5	Connection cordset, female, M12, 8-pin, right-angle, 5m * (homerun)
U0885-26	B 8181-0	Field-wireable, female, M12, 8-pin, straight,(6-8mm)
U0885-25	BS 8181-0	Field-wireable, male, M12, 8-pin, straight,(6-8mm)
A1050	KS 5/10 (10/LABELS)	Labels
U0135-6	PSG 3M-2	Cordset, male, M8x1, 3-pin, straight, 2m * (I/O port)
U0136-4	PSW 3M-2	Cordset, male, M8x1, 3-pin, right-angle, 2m * (I/O port)
U6427	PSGM-CC (8/BAG)	Dust cap, male, M8x1, Plastic, (8/BAG)
A900154	TORQUE-WRENCH-SET-M12&M8-LEGACY	Torque wrench set, Torque driver, torque setting tool, M12 fitting, M8 fitting.
A900101	PICOBX ADAPTOR PLATE, 4 PORT (1PACK)	Allows new picobox to utilize the previous version mounting hole locations.

* Other lengths available on request

Circuit Diagram

