

RI360P0-QR24M0-ELIU5X2-H1151/S1321

Contactless Encoder – Analog

Premium Line

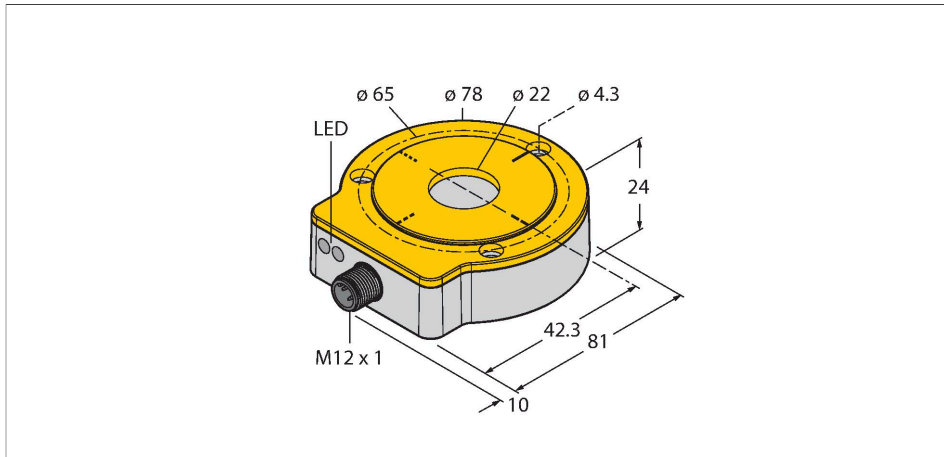

Features

- Compact, rugged housing
- Status displayed via LED
- Special printing; marking 90°, 180° and 270°
- Measuring range indicated via LED
- Immune to electromagnetic interference
- Measuring range programmable via Easy Teach
- Output signal programmable via Easy Teach
- Resolution, 16-bit
- 15...30 VDC
- 0...10 V and 4...20 mA
- Male M12 x 1, 5-pin

Technical data

| | |
|---|--|
| Type | RI360P0-QR24M0-ELIU5X2-H1151/S1321 |
| Ident. no. | 1590976 |
| Measuring principle | Inductive |
| Max. Rotational Speed | 12000 rpm |
| | Determined with standardized construction, with a steel shaft Ø 20 mm, L = 50 mm and reducer Ø 20 mm |
| Starting torque shaft load (radial / axial) | not applicable, because of contactless measuring principle |
| Resolution | 16 bit |
| Measuring range | 0...360 ° |
| Nominal distance | 1.5 mm |
| Repeat accuracy | ≤ 0.01 % of full scale |
| Linearity deviation | ≤ 0.05 %f.s. |
| Temperature drift | ≤ ± 0.004 % / K |
| Ambient temperature | -25...+85 °C |
| Operating voltage | 15...30 VDC |
| Residual ripple | ≤ 10 % U _{ss} |
| Isolation test voltage | ≤ 0.5 kV |
| Short-circuit protection | yes |
| Wire breakage/Reverse polarity protection | yes / yes (voltage supply) |
| Output type | Absolute singleturn |
| Resolution singleturn | 16 Bit |
| Output function | 5-pin, Analog output |

Wiring diagram

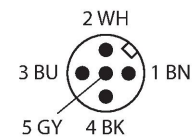
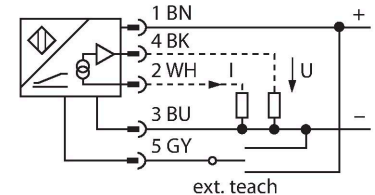

Functional principle

The measuring principle of inductive angle sensors is based on oscillation circuit coupling between the positioning element and the sensor, whereby an output signal is provided proportional to the angle of the positioning element. The rugged sensors are wear and maintenance-free, thanks to the contactless operating principle. They convince through their excellent repeatability, resolution and linearity within a broad temperature range. The innovative technology ensures a high immunity to electromagnetic DC and AC fields.

Technical data

| | |
|---|---|
| Voltage output | 0...10 V |
| Current output | 4...20 mA |
| Diagnostic | Positioning element not within detection range: Output signal 24 mA or 11 V |
| Load resistance voltage output | $\geq 4.7 \text{ k}\Omega$ |
| Load resistance, current output | $\leq 0.4 \text{ k}\Omega$ |
| Sample rate | 5000 Hz |
| Current consumption | < 50 mA |
| Design | QR24 |
| Dimensions | 81 x 78 x 24 mm |
| Flange type | Flange without mounting element |
| Shaft Type | Hollow shaft |
| Shaft diameter D [mm] | 6 6.35 9.525 10 12 12.7 14 15.875 19.05 20 |
| Housing material | Metal/plastic, ZnAlCu1/PBT-GF30-V0 |
| Electrical connection | Connector, M12 x 1 |
| Vibration resistance | 55 Hz (1 mm) |
| Vibration resistance (EN 60068-2-6) | 20 g; 10...3000 Hz; 50 cycles; 3 axes |
| Shock resistance (EN 60068-2-27) | 100 g; 11 ms ½ sinus; each 3x; 3 axes |
| Continuous shock resistance (EN 60068-2-29) | 40 g; 6 ms ½ sinus; each 4000 x; 3 axes |
| Protection class | IP68 / IP69K |
| MTTF | 138 years acc. to SN 29500 (Ed. 99) 40 °C |
| Power-on indication | LED, Green |
| Measuring range display | LED, yellow, yellow flashing |

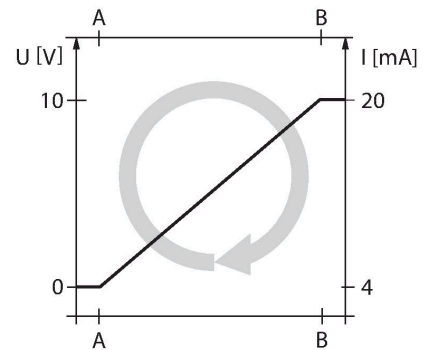

Mounting instructions

Mounting instructions/Description

A

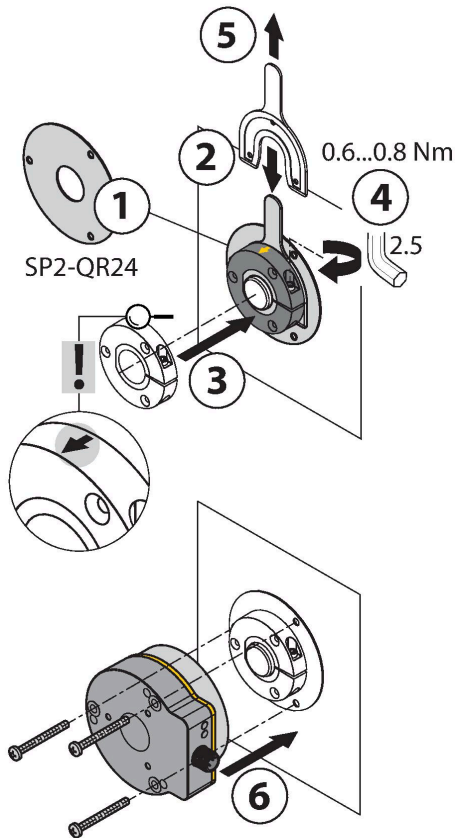

B

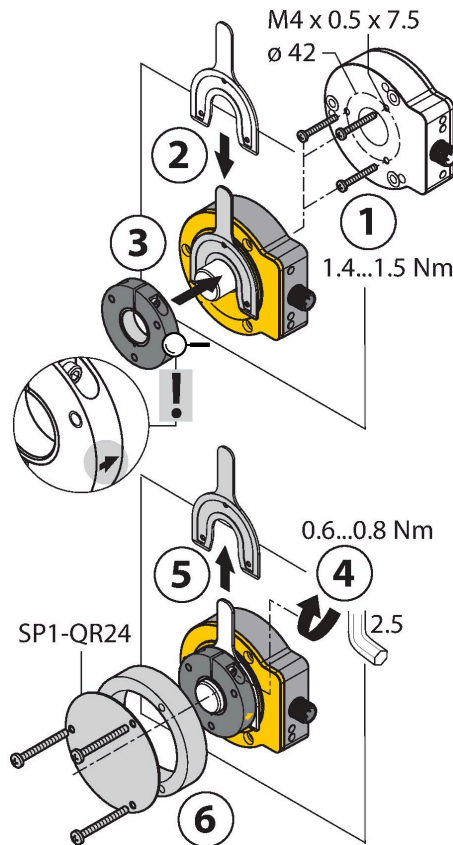

Extensive range of mounting accessories for easy adaptation to many different shaft diameters. Based on the functional principle of RLC coupling, the sensor operates absolutely wear-free and is immune to magnetized metal splinters and other interference fields. Wrong installation is hardly possible. The adjacent figure shows the two separate units, sensor and positioning element.

Mounting option A:

First, interconnect positioning element and rotatable shaft. Then place the encoder above the rotating part in such a way that you get a tight and protected unit.

Mounting option B:

Push the encoder on the back side of the shaft and fasten it to the machine. Then clamp the positioning element to the shaft with the bracket.

Mounting option C:

If the positioning element is to be screwed on a rotating machine part, use the RA0-QR24 plug which is included in the delivery. Then tie up the bracket. Screw on the encoder via the three bores.

The separately arranged sensor and positioning element inhibit that compensating currents or damaging mechanical loads are transmitted via the shaft to the sensor. In addition, the encoder remains tight and highly protected during its entire lifespan.

The accessories enclosed in the delivery help to mount encoder and positioning element at an optimal distance from each other. LEDs indicate the switching status.

Status display via LED

green steady:

Optimal sensor supply

yellow steady:

Positioning element has reached the end of the measuring range. This is indicated by a lower signal quality.

yellow flashing:

Positioning element is outside the measuring range.

off:

Positioning element is in the measuring range.

C

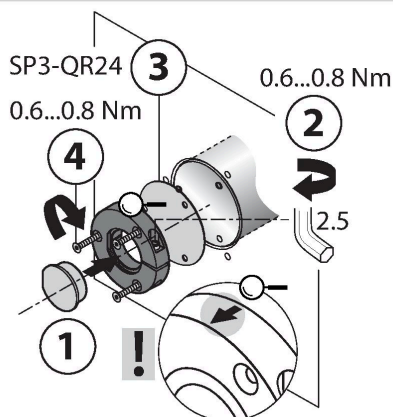

Default: 0°

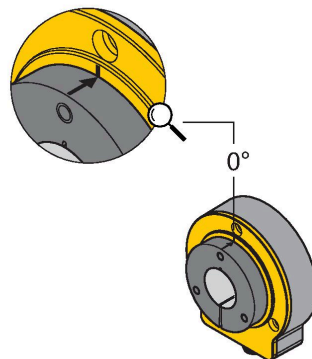

Individual Parameterization (Teaching with Positioning Element)

| | | | |
|---------------------------------------|--|---|--|
| Bridge between teach input Pin 5 (GY) | Gnd Pin 3 (BU) | Ub Pin1 (BN) | LED |
| 2 s | Start value | End value | Status LED flashes then turns steady after 2 s |
| 10 s | CCW rotation, then return to last preset value | CW rotation, then return to last preset value | After 10 s status LED flashes fast for 2 s |
| 15 s | - | Factory setting (360°, CW) | after 15 s power and status LED alternate |

To avoid unintended teaching, keep pin 5 potential-free.

Preset Parameterization (Teaching without Positioning Element)

| | | | |
|---|--|---------------------------------|--|
| Bridge pin between teach input Pin 5 (GY) | Gnd Pin 3 (BU) | Ub Pin 1 (BN) | LED |
| 2 s | Activate selection mode for output signal (for 10 s) | Activate preset mode (for 10 s) | Status LED steady, flashes after 2 s |
| 10 s | CCW rotation direction | CW rotation direction | After 10 s status LED flashes fast for 2 s |
| 15 s | | Factory setting (360°, CW) | After 15 s power and status LED flash equally fast |
| Output configuration | Gnd Pin 3 (BU) | | Status LED |
| I out: 4...20 mA | Press once | | 1 x flashing |
| I out: 0...20 mA | Press twice | | 2 x flashing |
| Uout: 0...10 V | Press three times | | 3 x flashing |
| Uout: 0...5 V | Press four times | | 4 x flashing |
| Uout: 0.5 V / 4.5 V | Press five times | | 5 x flashing |
| Preset mode / Angular range | | Ub Pin 1 (BN) | Status LED |
| 45° | | Press once | 1 x flashing |
| 60° | | Press twice | 2 x flashing |
| 90° | | Press three times | 3 x flashing |
| 180° | | Press four times | 4 x flashing |
| 270° | | Press five times | 5 x flashing |

To avoid unintended teaching, keep pin 5 potential-free.

Accessories

P1-RI-QR24 1590921

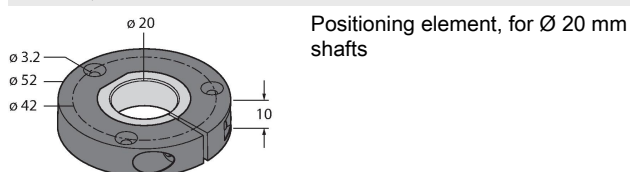

P2-RI-QR24 1590922

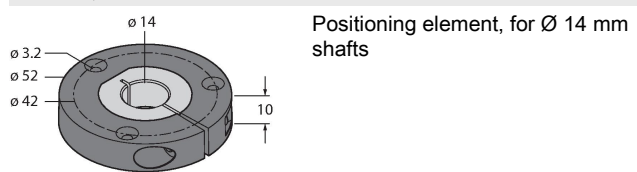

P3-RI-QR24 1590923

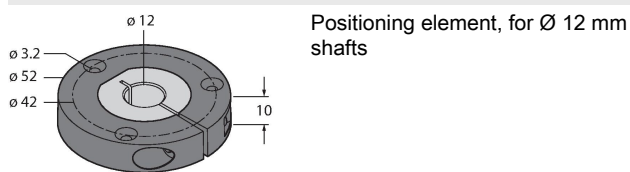

P4-RI-QR24 1590924

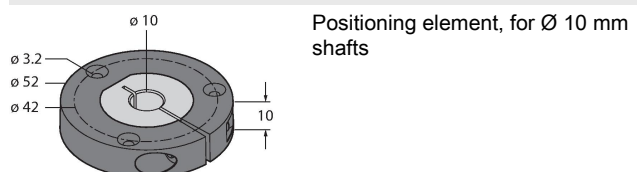

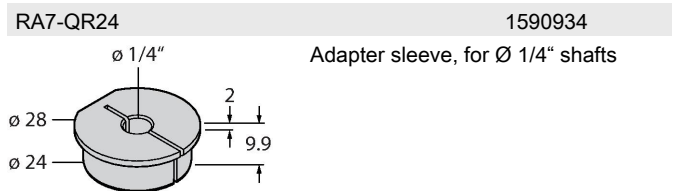
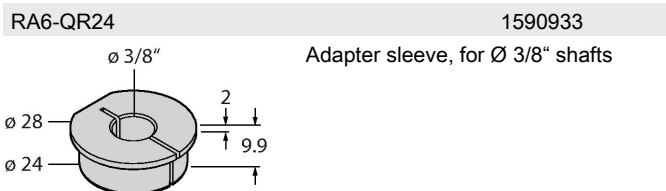
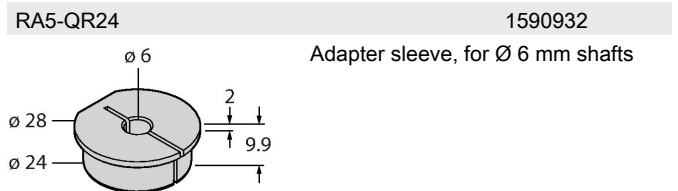
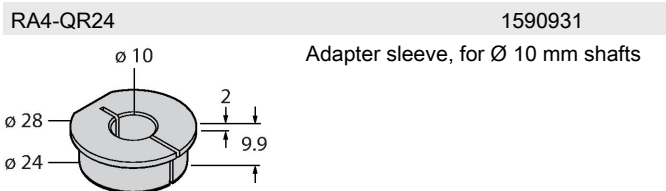
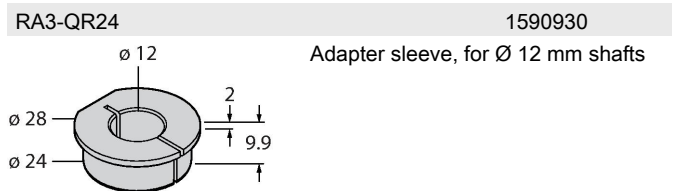
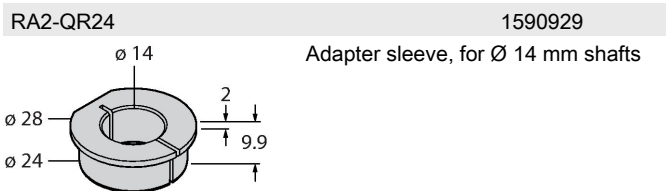
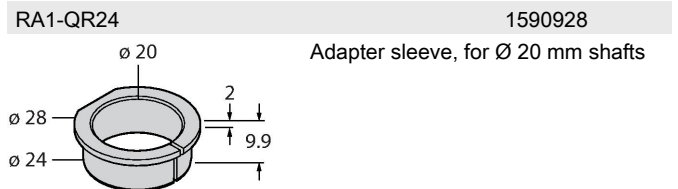
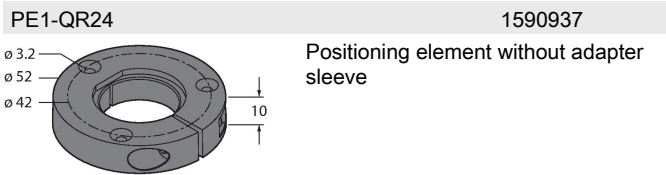
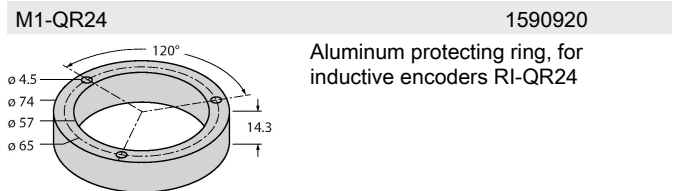
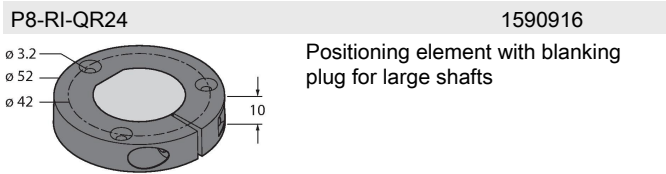
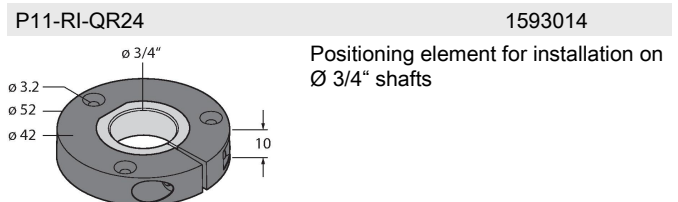
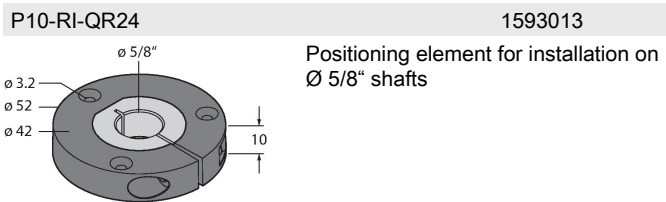
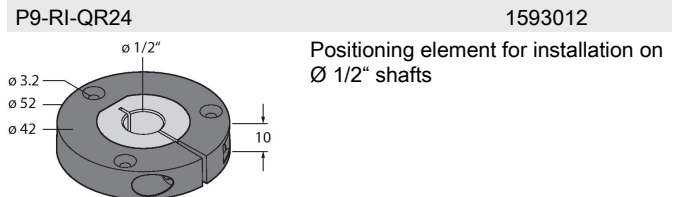
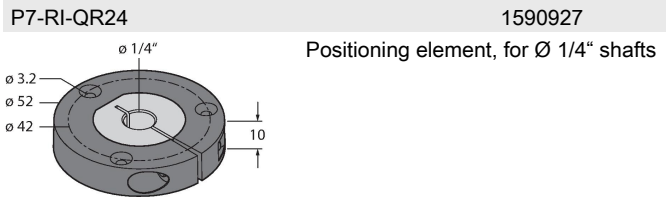
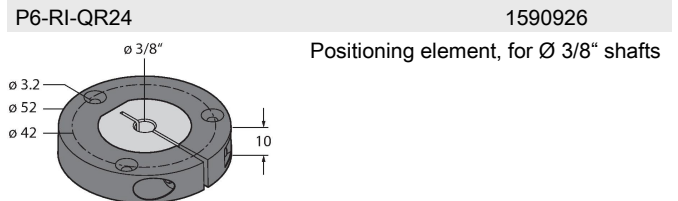
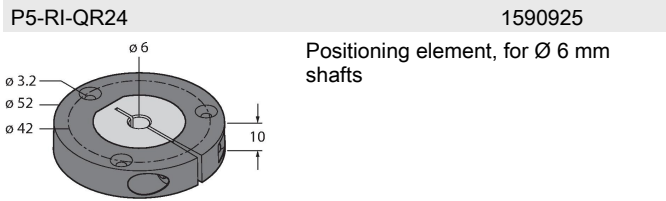

RA9-QR24 1590960 Adapter sleeve, for Ø 1/2" shafts

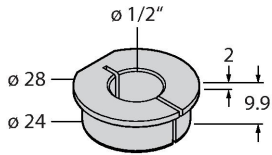

RA10-QR24 1590961 Adapter sleeve, for Ø 5/8" shafts

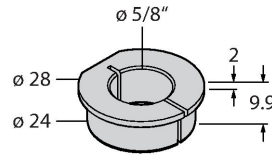

RA11-QR24 1590962 Adapter sleeve, for Ø 3/4" shafts

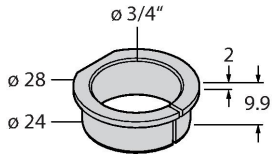

RA8-QR24 1590959 Plug for mounting option C

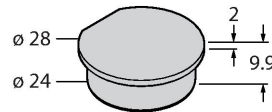

SP1-QR24 1590938 Shield plate Ø 74 mm, aluminium

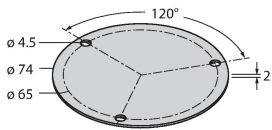

SP2-QR24 1590939 Shield plate Ø 74 mm, aluminium, with borehole for shaft feedthrough

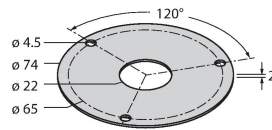

SP3-QR24 1590958 Shield plate Ø 52 mm, aluminium

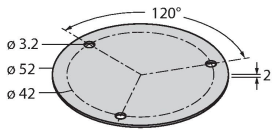

MT-QR24 1590935 Mounting aid for optimal alignment of positioning element

