

# Installation Efficient

# Product Solutions

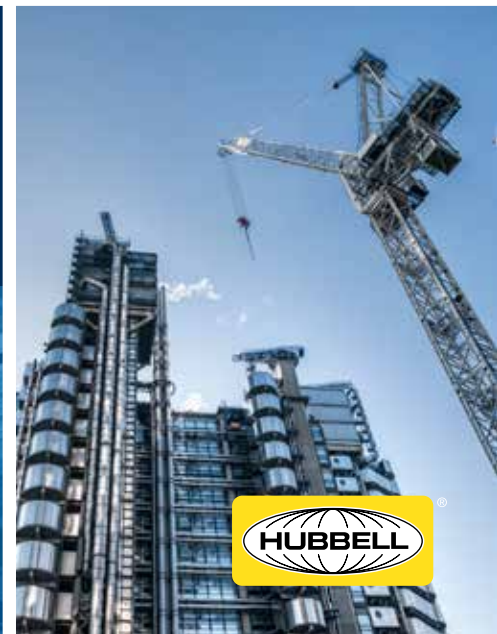

for Delivering Power, Data and AV





# Table of Contents

SNAPConnect® Devices	4
Hubbell SystemOne Floor Boxes	6
Hubbell SystemOne Fire-Rated Poke-Throughs	8
Configurable and Pre-Wired Devices	10
Prefabricated Solutions	11
Pre-Wired Raceway	12
Wall/Trench and Underfloor Duct	13
Wire Basket Tray, Preformed Fittings	14
Pre-Wired Access Floor Box System	15
Energy Efficiency	16
Services	18







**Tenant Build Out**



**Design/Build**



**Service Work**



## SNAPConnect® Devices

SNAPConnect® is the ideal solution for larger projects with the potential for future change outs. From new construction and renovation to demanding locations, SNAPConnect's modular design eliminates exposed live parts and replaces pigtails, which ensures consistent, safe and reliable connections during rough-in installation. Once walls are up, the protective covering is removed and the connector is simply snapped into the device. Going forward, the modular design supports simple device change out by maintenance personnel.

- Eliminates device wiring at trim out, allowing journeymen to focus on more critical tasks
- Ability to energize and test circuits at rough-in and resolve issues during less critical project stages
- Widest breadth of modular devices on the market

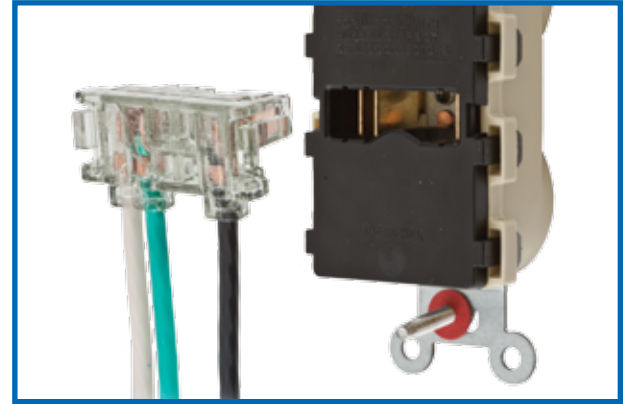

### Markets

- Healthcare
- Education
- Hospitality
- Commercial Construction
- Pre-Fab Assembly
- OEM



### SNAPConnect® Receptacles

Description	15A 125V		20A 125V	
	Standard	Hospital Grade	Standard	Hospital Grade
Duplex, Finder Groove Face	<b>SNAP5262WA</b>	<b>SNAP8200WA</b>	<b>SNAP5362WA</b>	<b>SNAP8300WA</b>
Style Line® Decorator	<b>SNAP2152WA</b>	<b>SNAP2172WA</b>	<b>SNAP2162WA</b>	<b>SNAP2182WA</b>
Tamper-Resistant, Smooth Face	<b>SNAP5262WTRA</b>	<b>SNAP8200WTRA</b>	<b>SNAP5362WTRA</b>	<b>SNAP8300WTRA</b>
USB Charger, Commercial Grade	<b>SNAP15USBW</b>	<b>SNAP8200USBW</b>	<b>SNAP20USBW</b>	<b>SNAP8300USBW</b>
GFCI, Commercial Grade	<b>GFRST15SNAPW</b>	<b>GFRST82SNAPW</b>	<b>GFRST20SNAPW</b>	<b>GFRST83SNAPW</b>
GFCI, Tamper/Weather Resistant	<b>GFTWRST15SNAPW</b>	<b>GFTWRST82SNAPW</b>	<b>GFTWRST20SNAPW</b>	<b>GFTWRST83SNAPW</b>

Shown in white. Also available in black, brown, gray, ivory, light almond and red.

### SNAPConnect® Extra-Heavy Duty Single Receptacles

Description	15A 125V		20A 125V	
	Standard	Hospital Grade	Standard	Hospital Grade
Standard	<b>SNAP5261W</b>	<b>SNAP8210W</b>	<b>SNAP5361W</b>	<b>SNAP8310W</b>
Tamper-Resistant	<b>SNAP5261WTR</b>	<b>SNAP8210WTR</b>	<b>SNAP5361WTR</b>	<b>SNAP8310WTR</b>

Shown in white. Also available in black, brown, gray, ivory, light almond and red.

### SNAPConnect® Right Angle Pigtailed Connector for Use with Receptacles

Description	Wire Type	General Use	Assembled in USA
Clear right angle terminal with 6 inch leads #12 AWG THHN/THWN-2;	Solid	<b>SNAP1RA</b>	<b>SNAP1RNA</b>
Polycarbonate housing material	Stranded	<b>SNAP2RA</b>	<b>SNAP2RNA</b>





### Supporting Literature



### Installation Efficiency

Available in standard, heavy duty and extra heavy duty specification grades, SNAPConnect® can reduce installation time and meet National Electrical Code® specialty device requirements in commercial, institutional and healthcare applications.

The SNAPConnect® family of connectors, receptacles and switches includes a wide variety, including Tamper-Resistant (TR), USB Charger, Isolated Ground (IG), Power Indicating LED and Surge Suppressing.

Duplex receptacles are available in standard or decorator faces, 15 or 20A.



### Labor Savings

*Save up to 5 minutes and complete your job in a SNAP*

Step 1: Rough-in the SNAPConnect® terminal instead of pigtails  
**Save one minute**



Step 2: Remove the protective packaging, attach the SNAPConnect® device to the circuit  
**Save over three minutes**



Step 3: Secure the mounting screws, attach the wallplate and the job is complete  
**Save over a minute**



### Additional Resources:

- Specification Sheets
- Videos
- eLearning
- Customer Drawings
- Installation Instructions
- Section 26 Specifications

## Related Products

### SNAPConnect® Circuit Tester with GFCI Test Button

#### 3-in-1 Tester

- Tests proper wiring of the SNAPConnect® receptacle terminal
- Tests proper wiring of standard receptacles
- Tests GFCI receptacles



### Terminal Customization

- Add -M2 to the end of any SNAPConnect® terminal part number to have WAGO® wire connectors pre-installed

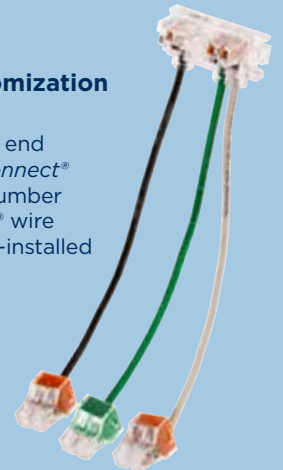

### SNAPConnect® Specification Grade Toggle Switches

Description	15A, 120-277V AC	20A, 120-277V AC
Single Pole	<b>SNAP1201WNA</b>	<b>SNAP1221WNA</b>
3-Way	<b>SNAP1203WNA</b>	<b>SNAP1223WNA</b>
Illuminated, Single Pole	<b>SNAP1201ILWNA</b>	<b>SNAP1221ILWNA</b>
Illuminated, 3-Way	<b>SNAP1203ILWNA</b>	<b>SNAP1223ILWNA</b>
Pilot Light, Single Pole	<b>SNAP1201PLWNA</b>	<b>SNAP1221PLWNA</b>

### SNAPConnect® Specification Grade Style Line® Decorator Switches

Description	15A, 120-277V AC	20A, 120-277V AC
Single Pole	<b>SNAP2101WNA</b>	<b>SNAP2121WNA</b>
3-Way	<b>SNAP2103WNA</b>	<b>SNAP2123WNA</b>
Illuminated, Single Pole	<b>SNAP2101ILWNA</b>	<b>SNAP2121ILWNA</b>
Illuminated, 3-Way	<b>SNAP2103ILWNA</b>	<b>SNAP2123ILWNA</b>
Pilot Light, Single Pole	<b>SNAP2101PLWNA</b>	<b>SNAP2121PLWNA</b>

Shown in white. Also available in black, brown, gray, ivory, light almond and red.

### SNAPConnect® Right Angle Pigttailed Connector for Use with Switches

Clear right angle terminal with 6-inch leads #12 AWG THHN/THWN-2, 600V wire

Description	Solid Wire	Stranded Wire
Single Pole (3 Wires)	<b>SNAPSP1NA</b>	<b>SNAPSP2NA</b>
Single Pole with Pilot	<b>SNAPSPP1NA</b>	<b>SNAPSPP2NA</b>
3-Way (4 Wires)	<b>SNAP3W1NA</b>	<b>SNAP3W2NA</b>



## Hubbell SystemOne Recessed Floor Boxes

Hubbell SystemOne creates a common look for fire-rated poke-throughs and floor boxes. This innovative system allows you to create custom solutions for multi-service applications that require both in-floor boxes and fire-rated poke-throughs. Regardless of capacity or installation, Hubbell SystemOne provides a uniform look throughout an entire building—whether the power, data, and AV are being delivered in the floor or through the floor.

- Fully adjustable floor boxes solve pre- and post-pour adjustment challenges
- Data and AV open system mounting plates satisfy customer requirements
- Same round cover design offer synergy between floor box and FRPT installations



### Markets

- Commercial Construction
- Education Facilities
- Hospitality
- Retail
- Stadiums



### Hubbell SystemOne Floor Boxes

Description	4" Round Covers	6" Round Covers		8" Round Covers		
			2-Gang	4-Gang	6-Gang	10-Gang
Floor Boxes	Non-Metallic	<b>CFBS1R4PFB*</b>	—	—	—	—
	Stamp Steel	<b>CFBS1R4SFB*</b>	<b>CFB2G25R</b> <b>CFB2G30R</b>	<b>CFB4G25R</b> <b>CFB4G30R</b>	<b>CFB6G30R</b>	<b>CFB10G55R</b>
	Corrosion Resistant	<b>CFBS1R4SFBCR*</b>	<b>CFB2G25CR</b> <b>CFB2G30CR</b>	<b>CFB4G25RCR</b> <b>CFB4G30RCR</b>	<b>CFB6G30RCR</b>	<b>CFB10G55RCR</b>
Device Mounting Plates	Decorator	<b>S1R4SPSTYLE</b>	<b>FBMPREC</b>	<b>FBMPREC</b>	<b>FBMPREC</b>	<b>FB10MPREC</b>
	Duplex	<b>S1R4SPDUPLEX</b>	<b>FBMPDUP</b>	<b>FBMPDUP</b>	<b>FBMPDUP</b>	<b>FB10MPDUP</b>
Covers	Aluminum	<b>CFBS1R4CVRALU</b>	<b>CFBS1R6CVRALU</b>	<b>CFBS1R8CVRALU</b>	<b>CFBS1R8CVRALU</b>	<b>CFBS1R8CVRALU</b>
	Black	<b>CFBS1R4CVRBLK</b>	<b>CFBS1R6CVRBLK</b>	<b>CFBS1R8CVRBLK</b>	<b>CFBS1R8CVRBLK</b>	<b>CFBS1R8CVRBLK</b>
	Brass	<b>CFBS1R4CVRBRS</b>	<b>CFBS1R6CVRBRS</b>	<b>CFBS1R8CVRBRS</b>	<b>CFBS1R8CVRBRS</b>	<b>CFBS1R8CVRBRS</b>
	Bronze	<b>CFBS1R4CVRBRZ</b>	<b>CFBS1R6CVRBRZ</b>	<b>CFBS1R8CVRBRZ</b>	<b>CFBS1R8CVRBRZ</b>	<b>CFBS1R8CVRBRZ</b>
	Gray	<b>CFBS1R4CVRGRY</b>	<b>CFBS1R6CVRGRY</b>	<b>CFBS1R8CVRGRY</b>	<b>CFBS1R8CVRGRY</b>	<b>CFBS1R8CVRGRY</b>
	Nickel	<b>CFBS1R4CVRNKL</b>	<b>CFBS1R6CVRNKL</b>	<b>CFBS1R8CVRNKL</b>	<b>CFBS1R8CVRNKL</b>	<b>CFBS1R8CVRNKL</b>

Note: \*Requires CFBS1R4CUP

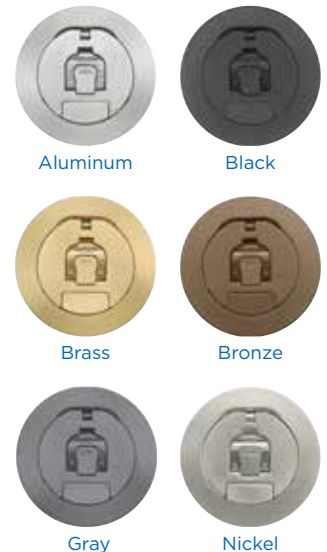



### Installation Efficiency

Hubbell SystemOne 4" recessed floor box features a patented installation cup and prewired 4-outlet plates that reduce labor costs.

Hubbell SystemOne 2-, 4-, 6- and 10-gang floor boxes are available with round or rectangular covers, prewired device plates include receptacles, extender caps for polished concrete installations or deep concrete pours.

Floor box stand eliminates the need for concrete blocks and speeds up installation of floor boxes during deeper concrete pours.

### Labor Savings

*Hubbell SystemOne Adjustable Mounting Cup*

### Installation Ease & Flexibility

Designed to allow for upwards adjustability in  $\frac{1}{32}$ " increments, our Adjustable Mounting Cup (AMC) speeds installation and supports a variety of floor height installations. The AMC is dropped into the floor box collar and rotated clockwise to set the height. Fully adjustable until the ground plate is installed, the AMC is locked into place by the plate, preventing unwanted adjustment of height.

### Supporting Literature



### Additional Resources:

- Specification Sheets
- Videos
- BIM Models
- Customer Drawings
- eLearning
- Installation Instructions
- Section 26 Specifications

## Related Products

### Pre-Pour Stackable Rings

- Stackable rings to increase box height by  $\frac{3}{4}$ " per ring

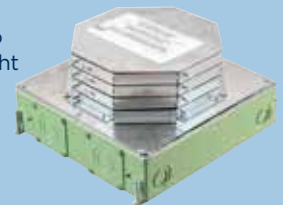

### Post-Pour Adjustment Rings

- Finished floor height adjustment rings



### PVC Floor Box Stand

- Pre-pour PVC stand increases box height 2.5-4.0 inches within the concrete pour



### Easy Mount Device Plates

Easy Mount device plates allow for a device to be mounted to the plate and wired outside of the floor box. The device and plate assembly are then easily installed and secured with one stud that locates the plate and one screw to secure it.

This patent-pending device fastening method maximizes efficiency while reducing install time and comes standard with all device plates for 2-, 4-, and 6-gang boxes.

Pre-wired duplex or Style Line® receptacles with 8-inch stranded leads are factory installed into the plates for even more labor savings. Tamper-resistant pre-wired devices are also available.



2-, 4-, 6-gang box plate



10-gang box plate



## Hubbell SystemOne Fire-Rated Poke-Throughs

Hubbell SystemOne Recessed Fire-Rated Poke-Throughs (FRPT) enhance functionality by providing increased power, data and AV capacity. Our 4", 6", 8" and 10" product offering will meet every requirement for today's applications and for future expansion. Pre-wired receptacles save time on the job-site when it really counts. The premarked controlled receptacles offer compliance to energy efficiency codes and standards. The open system data/AV sub-plates eliminate special adapters.

- Universal round recessed cover design and six finishes
- Excellent solution for retrofit and new construction
- Meets low voltage requirements for high capacity multimedia applications
- "Step down" allows wiring, installation and removal from the floor above
- ADA compliant



### Markets

- Commercial Construction
- Education Facilities
- Tenant Build Out
- Renovation



### Hubbell SystemOne Fire-Rated Poke-Throughs

Description	4" Round Covers	6" Round Covers	8" Round Covers	10" Round Covers
Fire-Rated Poke-Throughs	<b>S1R4PTFIT</b>	<b>S1R6PTFIT</b>	<b>S1R8PTFIT</b>	<b>S1R10PTFIT</b>
Device Mounting Plates	Quad	<b>S1R4SPQUAD</b>	<b>S1R6SPH</b>	—
	Quad Marked Controlled	—	<b>S1R6SPHC4</b>	—
	Duplex	—	<b>S1R6SPZ</b>	<b>S1R8PSPZ</b>
	Duplex Marked Controlled	—	<b>S1R6SPZC</b>	<b>S1R8PSPZC</b>
	Duplex Blank	<b>S1R4SPDUPLICATE</b>	<b>S1R6SPI</b>	<b>S1R8CSP</b>
StyleLine Blank	<b>S1R4SPSTYLE</b>	<b>S1R6SPK</b>	<b>S1R8CSPK</b>	<b>S1R10CSPD</b>
2-Gang StyleLine AV	—	<b>S1R6SPW</b>	<b>S1R8CSPM</b>	<b>S1R10CSPM</b>
Covers	Aluminum	<b>S1R4CVRALU</b>	<b>S1R6CVRALU</b>	<b>S1R8CVRALU</b>
	Black	<b>S1R4CVRBLK</b>	<b>S1R6CVRBLK</b>	<b>S1R8CVRBLK</b>
	Brass	<b>S1R4CVRBRS</b>	<b>S1R6CVRBRS</b>	<b>S1R8CVRBRS</b>
	Bronze	<b>S1R4CVRBRZ</b>	<b>S1R6CVRBRZ</b>	<b>S1R8CVRBRZ</b>
	Gray	<b>S1R4CVRGRY</b>	<b>S1R6CVRGRY</b>	<b>S1R8CVRGRY</b>
	Nickel	<b>S1R4CVRNKL</b>	<b>S1R6CVRNKL</b>	<b>S1R8CVRNKL</b>

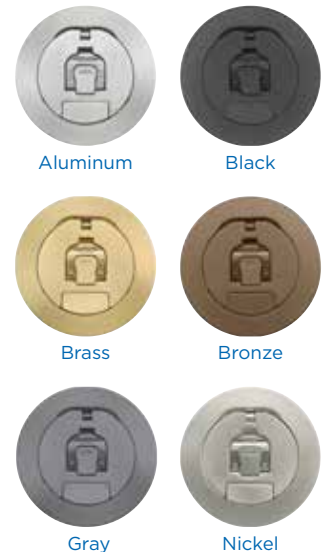



## Installation Efficiency

Hubbell SystemOne Recessed Fire-Rated Poke-Throughs deliver unmatched capacity and combinations of power, data and AV. Recessed connectivity, a low-profile flange, and egress doors that hinge inwards deliver improved safety and device protection. Choose from multiple sub-plate layouts and six cover finishes to support customized use and a consistent look across installation.



### 10 Inch Fire-Rated Poke-Through

Sub-plate layout for the center four gangs of the ten inch FRPT allows for maximum power or AV capacity.

Perimeter sub-plates complement the power or AV in the center four gangs. Additionally, these plates can be exchanged for other low voltage compatible plates.



### 8 Inch Fire-Rated Poke-Through

Sub-plate layout for the center three gangs of the eight inch FRPT can be configured to accommodate power and/or AV.

Perimeter sub-plates complement the AV or data in the center three gangs. Additionally, these plates can be exchanged for other low voltage compatible plates.



### 6 Inch Fire-Rated Poke-Through

An industry first, the 60/40 sub-plate layout allows for unmatched capacity with up to 12 keystone jacks and one 20A duplex.

50/50 sub-plate splits that accommodate AV and data with two Style Line® decorator devices are also available.



### 4 Inch Fire-Rated Poke-Through

The quad sub-plate can be wired on one circuit or two, and includes 12 inches of stranded wire.

2x2 sub-plates accommodating a duplex or Style Line® device and up to two keystone jacks are also available.

## Pre-Pour Tubes

Hubbell's Pre-Pour Tubes eliminate the cost and time of concrete core drilling for fire-rated poke-throughs. The tube provides a clean, concentric hole ready for FRPT installation and are easy to remove. All hardware is included.



### Pre-Pour Tubes

Includes all hardware

Diameter	Catalog Number
4 inches	<b>S1R4PPT</b>
6 inches	<b>S1R6PPT</b>
8 inches	<b>S1R8PPT</b>
10 inches	<b>S1R10PPT</b>

## Resources

### Supporting Literature



### Additional Resources:

- Videos
- BIM Models
- Customer Drawings
- eLearning
- Installation Instructions
- Section 26 Specifications

## Related Products

### Power Junction Box

- Allows for pre-termination of building wires from above



### Extension Kits

- Provides additional wiring chamber space for larger data/AV modules and jacks



S1R6SPEXT

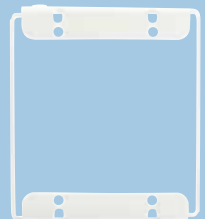

S1R8CSPEXT

### Abandonment Plates

- When an FRPT is no longer required, the 4," 6," 8," and 10" abandonment plates attached to the installed fittings maintain fire and scrub water ratings



## Configurable & Pre-Wired Devices

Hubbell's most popular 15 and 20 Amp standard receptacles are ready to meet your service, installation and design specifications. Ordered as a Hubbell Receptacle Special, our Duplex and Style Line® Decorator, Tamper-Resistant, Hospital Grade and SNAPConnect® are made to spec and modified to speed installation. All orders arrive in bulk packaging ready to install out of the box.

Common modifications include:

- Ear or bridge removal
- Mounting screws and autoground removal
- Wire leads
- Push-in connectors, ring or fork terminals

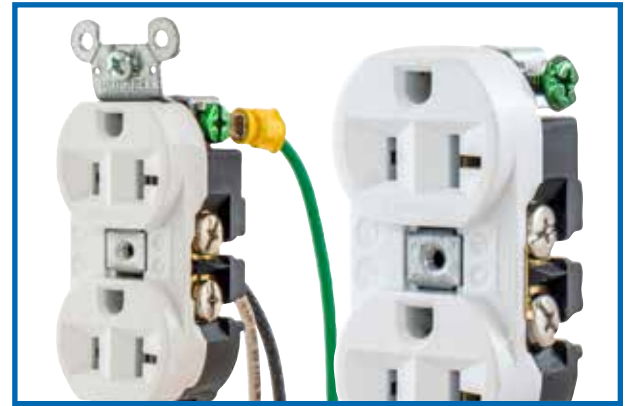

### Markets

- Education
- Hospitality
- Commercial Construction
- Pre-Fab Assembly
- OEM



### Prewired Tamper-Resistant Specification Grade Receptacles

Description	Wire leads	15A 125V	20A 125V
Duplex, smooth nylon face, side wired only, self-grounding	8" solid	<b>CR15WHITRP1</b>	<b>CR20WHITRP1</b>
	8" stranded	<b>CR15WHITRP2</b>	<b>CR20WHITRP2</b>
Style Line® decorator duplex, smooth nylon face, back and side wired, self-grounding	8" solid	<b>DR15WHITRP1</b>	<b>DR20WHITRP1</b>
	8" stranded	<b>DR15WHITRP2</b>	<b>DR20WHITRP2</b>

Shown in white. Also available in black, brown, gray, ivory and light almond.



### Hubbell Receptacle Special Ordering Process

- 1 Contact your Hubbell sales representative to discuss your customization needs.
- 2 After an order is placed, the receptacles will be made to specification, inspected, bulk packed and shipped.
- 3 Factory produced and delivered on time to keep your project on schedule!



Learn more

Find your Hubbell sales representative at [hubbell.com/wiringdevice-kellems/en](http://hubbell.com/wiringdevice-kellems/en), under the Company tab.



## Prefabricated Solutions

Hubbell's Rough-in Ready® System of pre-fabricated electrical support products is ideal for projects requiring repetitive wiring installation. All pre-fabricated assemblies and cables are labeled to match a detailed layout drawing. Any electrical project will profit from a Rough-in Ready® system, but projects with many similar rooms provide the biggest benefit to the installer.



- **Residential:** Apartments, Military and Campus Housing, Condominiums
- **Hospitality:** Hotels, Motels, Casino Resorts, Conference Centers
- **Healthcare:** Hospitals, Healthcare Facilities, Assisted Living

### Job Cost Savings

*Potential Advantage on Bid Day Calculator*

Job Cost Using the Rough-in Ready® System		Job Cost if You Were to Hardwire the Same Openings	
\$69,832.00	Rough-in Ready® System Cost	\$36,789.43	Estimated Material Cost
401.29	Projected Installation Hours	2,205.70	Estimated Installation Hours
45.00	Contractor's Fully Burdened Labor Rate	45.00	Contractor's Fully Burdened Labor Rate
<b>\$87,889.00</b>	<b>Total Installed Job Cost</b>	<b>\$136,045.93</b>	<b>Total Installed Job Cost</b>

	<b>1,804.41</b>	<b>Total Hours Saved</b>
	<b>81.81%</b>	<b>Total Labor Saving</b>
<b>Total Savings</b>	<b>\$48,155.97</b>	<b>Total Job Cost Savings or Your Potential Advantage on Bid Day</b>
	<b>35.40%</b>	<b>Total Percentage of Job Cost Savings</b>

### Hubbell Rough-in Ready® Ordering Process

- 1 Contact your Hubbell sales representative and provide specifications and drawings for the project.
- 2 Once quotation is accepted and purchase order is issued, Hubbell will provide a formal submittal for approval.
- 3 Product will be delivered in clearly marked skids by floor and area, depending on your job site requirements.



Learn more

Find your Hubbell sales representative at [hubbell.com/wiringdevice-kellems/en](http://hubbell.com/wiringdevice-kellems/en), under the Company tab.

### Supporting Literature



### Additional Resources:

- Customer Drawings
- Installation Instructions

## Related Products

### Prefabricated Components

- Time-saving exclusive components for your prefab shop



### Prefabricated Assemblies

- Custom prefab assemblies with Secure-Trim® device adjustment

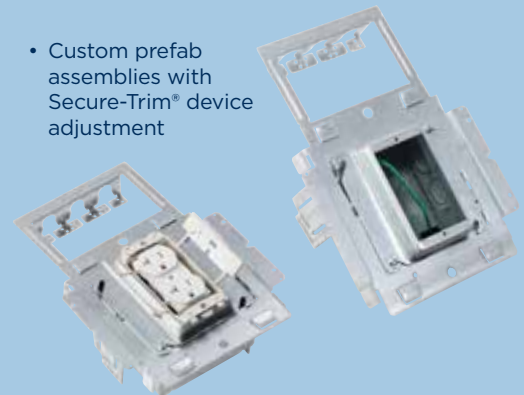

## Pre-Wired Raceway

Facility use has changed, and increased power and data requirements must keep pace with new demands. Hubbell Pre-Wired Raceway Systems accommodate changing requirements while keeping fast track projects on schedule. Our Application Engineers are your partner, completing the take off and providing quotes, preparing layout drawings and shipping products. Available in aluminum, steel and non-metallic, factory pre-cut and pre-wired lengths of raceway arrive ready for installation with all device cover plates, end caps, elbows and other required fittings. And, since aluminum raceway covers and cover plates are cut from the same extrusion, aesthetics are guaranteed.

- Handling and installation time reduces labor costs by up to 45%
- Issue one purchase order for a complete raceway system
- SNAPConnect® devices may be used for future proofing the installation



### Markets

- Education
- Retail
- Healthcare
- Research Laboratories
- Commercial Offices
- Work Bench Solutions



### Hubbell Pre-Wired Raceway Ordering Process

- 1 Contact your Hubbell sales representative and provide specifications and drawings for the project.
- 2 Upon receipt of an order, Hubbell's application engineer will provide a detailed product submittal for customer approval.
- 3 Raceway is shipped in clearly marked cartons with building number, floor, and/or room number referenced for easy job site installation.



Learn more

Find your Hubbell sales representative at [hubbell.com/wiringdevice-kellems/en](http://hubbell.com/wiringdevice-kellems/en), under the Company tab.



# Wall/Trench & Underfloor Duct

Hubbell offers a comprehensive offering of steel and aluminum duct products. Wall and trench duct is heavily utilized in the healthcare industry. Underfloor duct is ideal for hotel, retail, casino, and convention center applications. Hubbell's ability to design customized products for challenging projects can be an important resource for contractors and end users looking for the right product to meet demanding applications. Duct is available in a wide variety of widths, depths, and styles.



## Labor Savings

### Reduce Installation Time

Factory cut to length duct reduces labor time

Duct comes with dividers installed, eliminating on-site assembly

Professional take off service saves time and ensures accuracy

Factory compartmentalized underfloor duct reduces installation labor cost

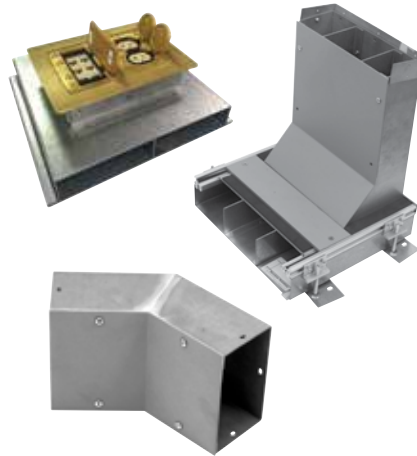

## Supporting Literature



## Additional Resources:

- BIM Models
- Videos
- Customer Drawings
- Installation Instructions
- Section 26 Specifications

## Related Products

### Healthcare Outlet Assemblies

*Expand outlet availability in patient care areas without renovating rooms*

- Only UL listed,\* CMS+ approved plug strip for patient care areas on the market today
- 15A and 20A models with four or six outlets available
- Mounting bracket available for easy attachment to IV poles
- May be ordered with or without surge protection



## Hubbell Duct System Ordering Process

- 1 Contact your Hubbell sales representative and provide job name, location, drawings, and specifications for the duct project.
- 2 Quotation and production lead time will be provided. Hubbell includes ground freight charges in each quotation. If submittals are needed, these will be completed once purchase order is issued to Hubbell.
- 3 All trench duct and wall duct orders are shipped under a generic TW prefix number, while floor duct projects are shipped under a generic FD part number.



Learn more

Find your Hubbell sales representative at [hubbell.com/wiringdevice-kellems/en](http://hubbell.com/wiringdevice-kellems/en), under the Company tab.

\*UL listed to UL2930 Health Care Outlet Assemblies  
†Centers for Medicare and Medicaid Services



# Wire Basket Tray

Hubbell Wire Basket Tray Systems are flexible and customized solutions that support a range of overhead and raised floor cable management applications. Two of our time- and material-saving options include Preformed fittings and No-Splice supports. Available in multiple sizes, Hubbell Pre-Formed Fittings reduce material costs and offer time savings over traditional cutting and splicing. No-Splice supports reduce material costs and ensure the tray's bottom rails are locked together.

- Preformed fittings reduce labor and installation by 90% versus traditional cutting and splicing
- T-weld construction eliminates possible snags when pulling wire
- Easy to cut, bend and splice for customization and field fabrication

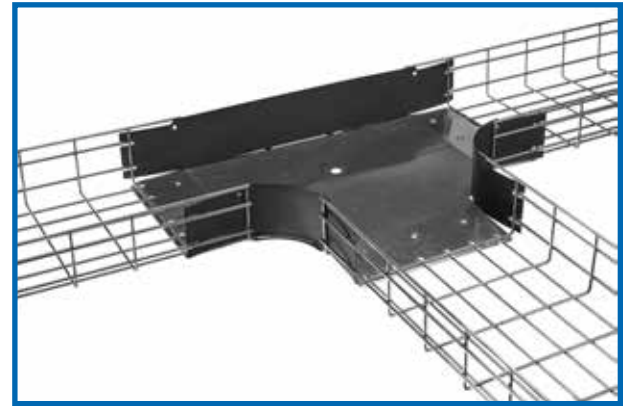

## Markets

- Data Centers
- Commercial Construction
- Stadiums
- Office Buildings



## Preformed Fittings

Tray	2" Deep Tray			4" Deep Tray			6" Deep Tray		
	90 Degree	Tee	45 Degree	90 Degree	Tee	45 Degree	90 Degree	Tee	45 Degree
4"	HBTR0204	HBTT0204	HBT450204	HBTR0404	HBTT0404	HBT450404	-	-	-
6"	HBTR0206	HBTT0206	HBT450206	HBTR0406	HBTT0406	HBT450406	-	-	-
8"	HBTR0208	HBTT0208	HBT450208	HBTR0408	HBTT0408	HBT450408	HBTR0616	HBTT0608	HBT450608
12"	HBTR0212	HBTT0212	HBT450212	HBTR0412	HBTT0412	HBT450412	HBTR0612	HBTT0612	HBT450612
16"	HBTR0216	HBTT0216	HBT450216	HBTR0416	HBTT0416	HBT450416	HBTR0616	HBTT0616	HBT450616
18"	HBTR0218	HBTT0218	HBT450218	HBTR0418	HBTT0418	HBT450418	HBTR0618	HBTT0618	HBT450618
20"	HBTR0220	HBTT0220	HBT450220	HBTR0420	HBTT0420	HBT450420	HBTR0620	HBTT0620	HBT450620
24"	HBTR0224	HBTT0224	HBT450224	HBTR0424	HBTT0424	HBT450424	HBTR0624	HBTT0624	HBT450624

Note: Add **BK** suffix for black base tray. Add **SW** suffix for steel side walls.

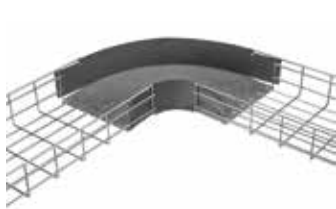

## No Splice Supports

Tray	Center Support	Ceiling Support
6"	HBTNSCTRS6	-
8"	HBTNSCTRS8	-
12"	HBTNSCTRS12	HBTNSCLGS12
16"	HBTNSCTRS16	HBTNSCLGS16
18"	HBTNSCTRS18	HBTNSCLGS18
20"	HBTNSCTRS20	HBTNSCLGS20
24"	HBTNSCTRS24	HBTNSCLGS24

Note: Install every 5 feet.  
Splice hardware included.





## Pre-Wired Access Floor Box System

Custom engineered and wired to project specifications, the Hubbell CONNEXION 2.0 Zone Distribution System is a factory-assembled, modular plug-n-play system for raised floor installations. The Zone Distribution Box (ZDB) in conjunction with multi-conductor extender cables, splitters, and point of service units create a flexible, easy to use, 20 amp modular wiring system.

CONNEXION 2.0 also includes a furniture feed distribution box that delivers power, voice and data to powered furniture at the floor level for a clean, aesthetically-pleasing installation.



### Labor Savings

*Reduce Administrative and Job Site Costs*

Hubbell takeoff service reduces administrative expenses and time

Eliminates job site fabrication time and cuts installation labor

Plug-n-play system is tested at the factory for trouble-free installation

Available in four system configurations for tailored wiring



### Hubbell Pre-Wired Floor Box Ordering Process

- 1 Contact your local Hubbell sales representative and provide project information, including specifications and drawings.
- 2 Hubbell application engineer will provide system design, quotation, and submittal for customer approval.
- 3 Product is shipped as required by installer to the job site for a labor saving installation. Order is manufactured in our US factory, and ships to the job site ready for installation.



Learn more

Find your Hubbell sales representative at [hubbell.com/wiringdevice-kellems/en](http://hubbell.com/wiringdevice-kellems/en), under the Company tab.

## Resources

### Supporting Literature



### Additional Resources:

- Installation Videos
- BIM Models
- Videos
- Customer Drawings
- Installation Instructions
- Section 26 Specifications

## Related Products

### Zone Distribution Boxes

- The main interface between the existing electrical system and the labor-saving CONNEXION 2.0 system



### Splitters

- Increases the number of floor boxes fed from a single Zone Distribution Box



### RAFB4 Series Boxes

- Fits into the same size hole as an 8" round air diffuser



## Adaptive Technology Occupancy Sensors

Adaptive Technology is Hubbell's patented breakthrough in advanced controls that eliminates manual adjustment. Available on the majority of our occupancy/vacancy low voltage and switch sensors, smart microprocessors constantly monitor the controlled area and adjust the sensitivity and timer based on environmental history and automatically adjust for seasonal changes, modified airflow, furniture layout or occupancy pattern changes. No initial configuration is required, making this an "install and forget" solution.

- Lower energy costs and utility bills
- No need to manually adjust for occupancy changes
- Install and forget installation



### Markets

- Education
- Hospitality
- Commercial Construction
- Office Buildings
- Healthcare



### Adaptive Technology Wall Switch Sensors

Description	Single Circuit (1 button)	Dual Circuit (2 buttons)
<b>Dual (Ultrasonic and Passive Infrared)</b>		
Selectable Manual/Auto ON	<b>AD2000W1</b>	<b>AD2000W22</b>
Manual ON (Vacancy)	<b>AD2001W1</b>	<b>AD2001W22</b>
<b>Passive Infrared with 0-10V Dimming</b>		
Selectable Manual/Auto ON	<b>APD2000W1</b>	—
Manual ON (Vacancy)	<b>APD2001W1</b>	—

24V DC, 33mA. Requires a CU300xx series control unit.

#### Dual (Ultrasonic and Passive Infrared)

Selectable Manual/Auto ON	<b>AD2240W1</b>	<b>AD2240W2</b>
Manual ON (Vacancy)	<b>AD2240W1</b>	<b>AD2241W2</b>

Note: Also available in black, gray, ivory and light almond.



### Low Voltage Adaptive Technology Wall Mount Sensors

Description	Coverage	Catalog Number
<b>Dual (Ultrasonic and Passive Infrared)</b>		
Sensor 32kHz with photocell and isolated relay	1600 sq ft	<b>ATD1600WRP</b>

#### Passive Infrared Sensor

For aisle and high bay applications, with photocell and isolated relay 120 linear ft **ATP120HBRP**

Note: All wall mount sensors must use a CU300M control unit.



### Adaptive Technology Ceiling Mount Sensors

Description	Voltage	Coverage Area	
		2000 sq. ft. (360°)	1000 sq. ft. (180°)
<b>Dual (Ultrasonic and Passive Infrared)</b>			
Low voltage sensor*	24V DC	<b>ATD2000CRP</b>	<b>ATD1000CRP</b>
Line voltage sensor	120-277V AC	<b>ATD2000CL</b>	<b>ATD1000CL</b>
<b>Passive Infrared</b>			1500 sq. ft. (360°)
Low voltage sensor*	24V DC	—	<b>ATP1500CRP</b>
Line voltage sensor	120-277V AC	—	<b>ATP1500CL</b>

Note: Low voltage ceiling sensors must use a CU300M control unit.

\*Low voltage sensors include isolated relay and photocell.



## Low Voltage Dimming Control

The Hubbell Low Voltage Wall Switch with 0-10V Dimming is the absolute choice for applications requiring occupancy-based control and low voltage dimming.

Because of its simplicity in design and operation, the device is ideal for use in private offices, conference rooms, classrooms and multimedia learning centers.



### Labor Savings

*Energy Efficient Dimming Control*

### Installation Speed & Flexibility

The device's compact design and dual functionality allow the use of a smaller electrical wall box, simplifies installation and speeds up commissioning process. Also, the device is fully compatible with existing Hubbell load control units. There is no need to replace with newer systems.



### Low Voltage Wall Switches with 0-10V Dimming

Description	Catalog Number
Manual ON operation mode	<b>DSM010W</b>
Auto ON operation mode	<b>DSL010W</b>
Bi-Level Switching Control: 1 Load Auto ON 1 Load Manual ON	<b>DSC010W</b>

Shown in white. Also available in ivory, light almond and gray.



### Control Unit

Description	Catalog Number
Manual ON operation; 100-277V AC, 50/60Hz for use with 1-4 ATD, ATU, ATP and AD2240 series sensors	<b>CU300M</b>



### Supporting Literature



### Additional Resources:

- Videos
- Specification Sheets
- FAQ Reference Guide
- Customer Drawings
- Installation Instructions
- Section 26 Specifications

## Related Products

### Switched Receptacles for Automatic Receptacle Control

- Wireless receiver capable of controlling additional downstream receptacles



### Photocell for Automatic Dimming Control

- Efficiently blends natural and artificial light to provide precise daylight harvesting control



### Heavy Duty Control Unit

- Provides power to sensors for automatic receptacle control





## Services

Ready to increase installation efficiency with quality products? We're here to help.

Space design, jobsite challenges and wiring systems are changing. We can help make the most of the newest innovations so you can focus on successfully completing more projects in less time.

From new construction and renovations to industrial, commercial, medical or residential structures, we manufacture quality systems that reduce installation time and support the latest design aesthetics. We also partner with several companies to make specifying, installing and using Hubbell products easy, and efficient.

### Project Design

Our team of Application Engineers support project design work, from bid to installation for several Hubbell product lines including:

- Trench, wall and underfloor duct
- Pre-wired raceway
- CONNEXION plug-n-play raised access floor power distribution systems
- Lighting control/occupancy sensor layout and design

### Takeoff Services

Hubbell Application Engineers can perform pre- or post-bid takeoffs for a variety of product lines:

- Wiring Devices
- Floor Boxes
- Fire-Rated Poke-Throughs
- Wire Basket Tray Systems
- Sensors
- Surface Raceway
- Power Poles

### Submittal Builder

Hubbell's industry best submittal builder is available for distributors, contractors, and others on Hubbell's public website. Submittals can include all or some of the following documents: catalog page, data sheet, drawing and installation instructions. A link to the submittal, or a PDF copy, can easily be emailed.

- Fast
- Professional
- Thorough

**Hubbell Duct Solutions** Quote No: ABC-1234-2018

Date: 8/1/2018  
Job Name: Memorial Hospital Renovation  
Location: United States of America  
Contractor: ACME Electric

Qty	Catalog Number	Description	Price
1	CT Scan RM 1105		
1	OKA/D6-2C-1/4	Two Compl Trench Duct 3-1/2 x 6 x 72 with 1/4 Cover	
1	OKA/D6-2C-1/4 x 24	Two Compl Trench Duct 3-1/2 x 6 x 24 with 1/4 Cover	
2	OKL25/D6-2C-1/4	Two Compl Trench Duct Horizontal 25 Elbow 3-1/2 x 6	
2	OKE/D6	Trench Duct End Cap 3-1/2 x 6	
1	OWR/DF	Trench to Wall Duct Riser 3-1/2 x 6 Flush	
3	OWA/D6S	Wall Duct 3-1/2 x 6 x 60 with Surface Cover	
4	OWE/D6S	Wall Duct End Cap 3-1/2 x 6 Surface	
3	OWA/DFP	Wall Duct 3-1/2 x 6 x 90 with Flush Cover	
2	OWE/DFE-6	Wall Duct Flush to Surface Adapter 6 - 6	
3	OWE/DF	Wall Duct End Cap 3-1/2 x 6 Flush	
9	OWP/D	Wall Duct Divider	
1	GRDM-15	15" Grommet Material	

Example Duct Takeoff and Quotations

Project Name: Community College  
Address: \_\_\_\_\_  
Take-off: Aluminium Raceway  
Date on Drawing: 5/7/2018  
Prepared By: \_\_\_\_\_  
Checked By: \_\_\_\_\_

Sl.No.	Product	Catalog No.	Qty	Unit	Catalog Links
1	Raceway-1				
	Single Channel Base	HBLALU3800B10	500	ft	<a href="#">Click Here</a>
	Single Channel Cover	HBLALUC5	500	ft	<a href="#">Click Here</a>
	Wire Clip	HBLALJWC	150	ea	<a href="#">Click Here</a>
	Coupling (Pair)	HBLALJD1	25	ea	<a href="#">Click Here</a>
	Blank End Fitting	HBLALJH10B	80	ea	<a href="#">Click Here</a>
	Duplex receptacle on Raceway		72	ea	
	Coverplate for Duplex receptacle on Raceway		72	ea	
	Emergency Duplex receptacle on Raceway		50	ea	
	Coverplate for Emergency Duplex receptacle on Raceway		50	ea	
	Emergency GFI Duplex receptacle on Raceway		50	ea	
	Coverplate for Emergency GFI Duplex receptacle on Raceway		50	ea	

**Scale Notes:**  
1. The length measuring tool used for our takeoff activity is PDF Exchange Viewer. The default scale in this tool is 1 inch = 1 inch.  
2. For this Project, Numerical Scale from the drawing sheet is: 1/8" = 1'-0". So 1'-0" = 8 inches. Hence each section length measured in inches from the drawing sheet is 8 times the actual length.  
3. To ensure the correctness of scale, we have also measured the downways and have ensured as follows.

**General Notes:**  
1. We have tried assigning catalog numbers referring raceway descriptions given in drawing sheets/Specsheets.  
2. Conduit Raceways are not considered in this takeoff.  
3. Receptacles on raceways are calculated for the purpose of coverplates calculations only.

Example Takeoff

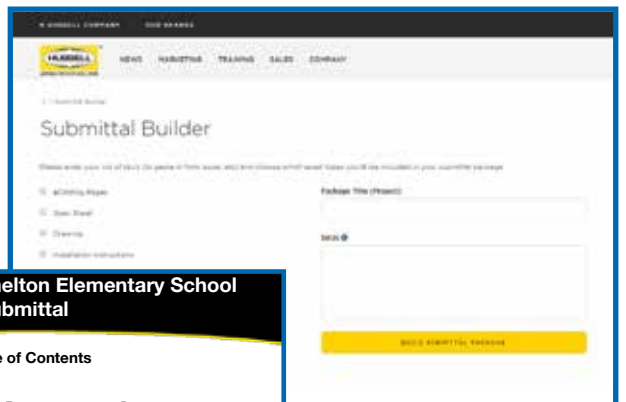

Create a submittal at [www.hubbell-wiring.com](http://www.hubbell-wiring.com)

**Shelton Elementary School Submittal**

SKU	Asset Type	Page
SNAP5362WA	eCatalog Page	2
	CAD Drawing	3
	Installation Instructions	4
GFRST20SNAPW	eCatalog Page	6
	CAD Drawing	7
	Installation Instructions	8
SNAP20USBW	eCatalog Page	11
	CAD Drawing	12
	Installation Instructions	13
SNAP2RA	eCatalog Page	14
	CAD Drawing	15
	Installation Instructions	16
SNAPSP2NA	eCatalog Page	18
	CAD Drawing	19
	Installation Instructions	20

## Product Resources

CAD and PDF drawings are available for download on Hubbell's public website with detailed dimensional information on all Hubbell products.

A large library of Isometric and Flat product drawings for use in engineering plans are also housed on Hubbell's public website. These are ideal for ensuring that the electrical contractors are clear on the product that is required for all varieties of projects.

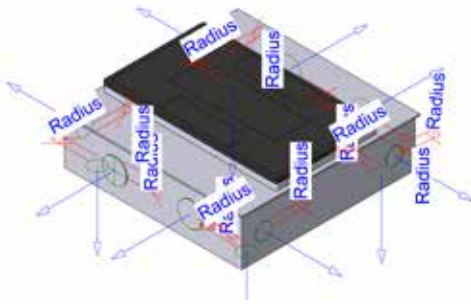

Comprehensive library of BIM models for design engineers and design/build contractors

Flat and isometric drawings for use on design engineer plans

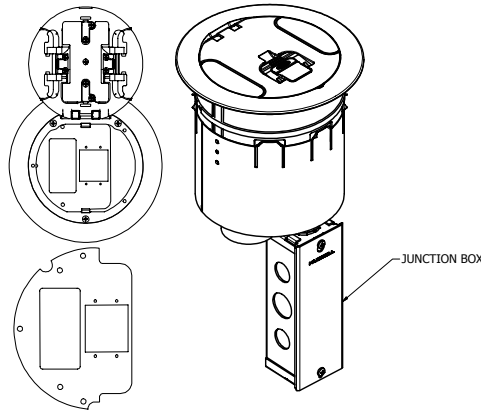

S1R6SPX

S1R6PTFIT

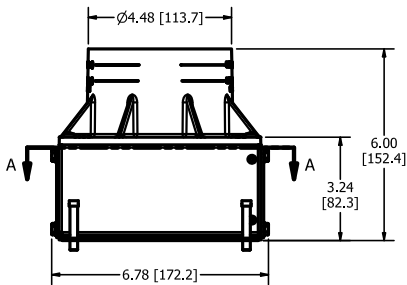

Product drawings with dimensional data in PDF and DWG formats

## Our Partners

Hubbell has partnered with a number of companies that provide additional resources to our design engineer customers and our design build contractors.



### BSD Softlink

- Hubbell and BSD Softlink partner to provide Hubbell specifications to subscribers of BSD's specification service.



### BIM Object

- Hubbell and BIM Object partner to provide BIM models for a wide variety of Hubbell products on BIM Objects industry leading BIM warehouse site.



### MasterSpec

- Hubbell partners with MasterSpec to provide CSI MasterFormat specifications on MasterSpec's industry leading site.



### ConstructConnect

- Hubbell's field sales organization utilizes the ConstructConnect project search tool to track projects across the United States. From pre-planning to post bid, ConstructConnect provides Hubbell's sales team access to current specifications and plans for many public and private construction projects.

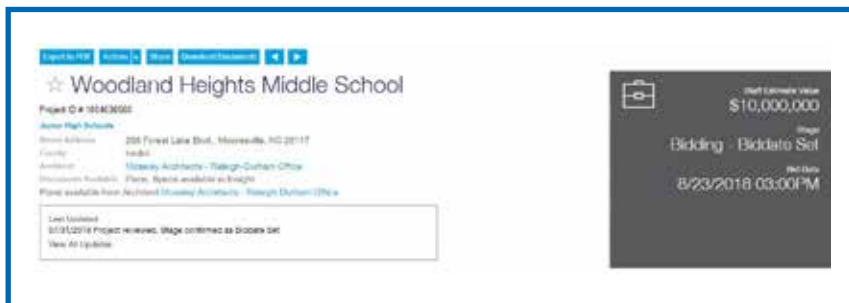

ConstructConnect Example Project

# Installation Efficient Product Solutions



New Construction



Renovation



Tenant Build Out



Design/Build



Service Work



SNAPConnect® Devices



Hubbell SystemOne Floor Boxes and FRPTs

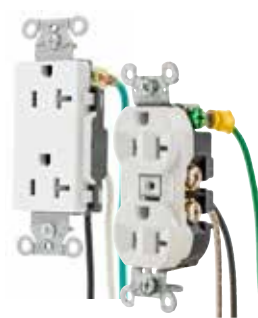

Pre-wired and Configurable Devices



Prefabricated Solutions



Pre-Wired Raceway

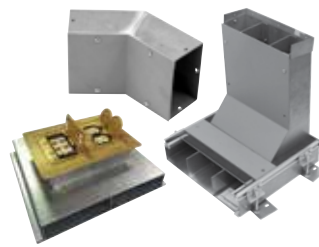

Wall/Trench and Underfloor Duct



Wire Basket Tray



Adaptive Technology and Wireless Load Control

## Hubbell Product Literature



10 Inch Fire-Rated Poke-Throughs

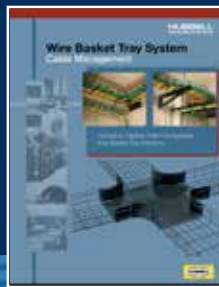

Wire Basket Tray



Fully Adjustable 4 Inch Round Recessed Floor Boxes

**HUBBELL**<sup>®</sup>  
Wiring Device-Kellems

[www.hubbell.com/wiringdevice-kellems/en](http://www.hubbell.com/wiringdevice-kellems/en)

