



Price* : 86.00 USD



Main

Range of product	Harmony Timer Relays
Product or component type	Multifunction relay
Electrical connection	Plug-in sub-base 11
Discrete output type	Relay
Contacts type and composition	2 C/O timed contacts, AgNi (cadmium free)
Component name	RE48A
Time delay type	Power on-delay Interval Off-delay Symmetrical flashing
Time delay range	0.5...30 s 5...300 s 0.2...12 min 0.5...30 h 2...120 s 0.05...3 s 0.2...12 s 0.02...1.2 s 2...120 min 5...300 min 0.5...30 min 5...300 h 2...120 h 0.2...12 h
[Us] rated supply voltage	24...240 V AC/DC 50/60 Hz
Voltage range	0.85...1.1 Us AC 0.9...1.1 Us DC
Line Rated Current	5 A

* Price is "List Price" and may be subject to a trade discount – check with your local distributor or retailer for actual price.

Complementary

Product front plate size	48 x 48 mm
Control type	Selector switch front panel
Housing material	Self-extinguishing
Repeat accuracy	+/- 0.2 % of the maximum setting value IEC 61812-1
Temperature drift	+/- 0.02 %/°C of the maximum setting value IEC 61812-1
Voltage drift	+/- 0.2 %/V of the maximum setting value 48...240 V +/- 1 %/V of the maximum setting value 24...48 V
Setting accuracy of time delay	+/- 5 % of full scale 25 °C IEC 61812-1
Minimum pulse duration	20 ms
Reset time	25 ms on de-energisation
Pick up duration	55 ms
On-load factor	100 %
Power consumption in VA	1.1 VA 24 V 4.8 VA 240 V
Power consumption in W	0.5 W 24 V 1.7 W 240 V
Breaking capacity	1250 VA
Minimum switching current	100 mA
Maximum switching current	5 A
Maximum switching voltage	250 V AC/DC
Electrical durability	100000 cycles
Mechanical durability	30000000 cycles
Output voltage	240 V 5 A AC-12 30 V 2 A DC-13 240 V 1.5 A AC-15
Marking	CE
Surge withstand	1 kV differential mode IEC 61000-4-5 level 3 2 kV common mode IEC 61000-4-5 level 3
Mounting support	Base mounted: socket Panel mounted: system supplied with the product
Local signalling	for output relay state 1 LED (yellow) for flashing: relay energised timing in progress LED indicator (green) for on steady: relay energised, no timing in progress LED indicator (green)
Net Weight	0.31 lb(US) (0.14 kg)

Environment

Humidity drift	+/- 0.05 %/%RH of the maximum setting value IEC 61812-1
Immunity to microbreaks	10 ms
Dielectric strength	1 kV 1 mA/1 minute IEC 61812-1
Protection against electric shocks	4 kV class III IEC 60664-1 4 kV class III IEC 61812-1
Standards	IEC 61812-1 EN 50081-1/2 93/68/EEC 89/336/EEC EN 50082-1/2 IEC 60669-2-3 73/23/EEC
Product certifications	UL CULus CSA C-tick
Ambient air temperature for storage	-40...158 °F (-40...70 °C)
Ambient air temperature for operation	-4...122 °F (-20...50 °C)
IP degree of protection	IP40 IEC 60529 housing) IP50 IEC 60529 front face)

Vibration resistance	0.35 mm 10...55 Hz)IEC 60068-2-6
Relative humidity	93 % without condensation IEC 60068-2-3
Resistance to electrostatic discharge	6 kV in contact EN/IEC 61000-4-2 level 3 8 kV in air EN/IEC 61000-4-2 level 3
Resistance to electromagnetic fields	9.14 V/m (10 V/m) 26 MHz to 1 GHz IEC 61000-4-3 level 3
Resistance to fast transients	2 kV EN/IEC 61000-4-4 level 4 capacitive connecting clip) 4 kV EN/IEC 61000-4-4 level 4 direct)
Immunity to radioelectric fields	10 V 0.15...80 MHz)EN/IEC 61000-4-6 level 3
Immunity to voltage dips	30 % / 10 ms EN/IEC 61000-4-11 60 % / 100 ms EN/IEC 61000-4-11 95 % / 5 s EN/IEC 61000-4-11
Disturbance radiated/conducted	Class B 0.15...30 MHz EN 55022 (EN 55011 group 1)

Ordering and shipping details

Category	22370 - RE, RM MISC TIMERS & COUNTERS
Discount Schedule	CP2
GTIN	03389110649598
Nbr. of units in pkg.	1
Package weight(Lbs)	4.59 oz (130 g)
Returnability	Yes
Country of origin	ID

Packing Units

Unit Type of Package 1	PCE
Package 1 Height	2.24 in (5.7 cm)
Package 1 width	2.44 in (6.2 cm)
Package 1 Length	4.13 in (10.5 cm)

Offer Sustainability

Sustainable offer status	Green Premium product
California proposition 65	WARNING: This product can expose you to chemicals including: Nickel compounds, which is known to the State of California to cause cancer, and Di-isodecyl phthalate (DIDP), which is known to the State of California to cause birth defects or other reproductive harm. For more information go to www.P65Warnings.ca.gov
REACH Regulation	REACH Declaration
EU RoHS Directive	Pro-active compliance (Product out of EU RoHS legal scope) EU RoHS Declaration
Mercury free	Yes
RoHS exemption information	Yes
China RoHS Regulation	China RoHS declaration
Environmental Disclosure	Product Environmental Profile
Circularity Profile	End of Life Information
WEEE	The product must be disposed on European Union markets following specific waste collection and never end up in rubbish bins.

Contractual warranty

Warranty	18 months
----------	-----------

Width 48 mm

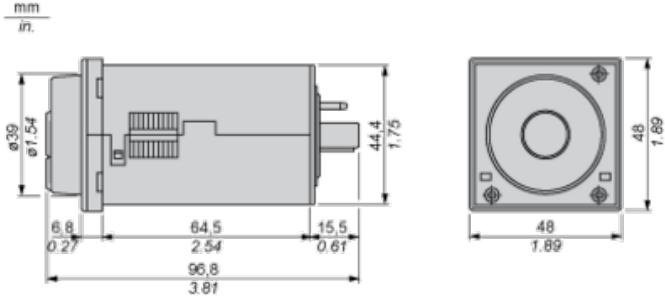

Panel Cut-Out and Mounting

Panel Cut-Out

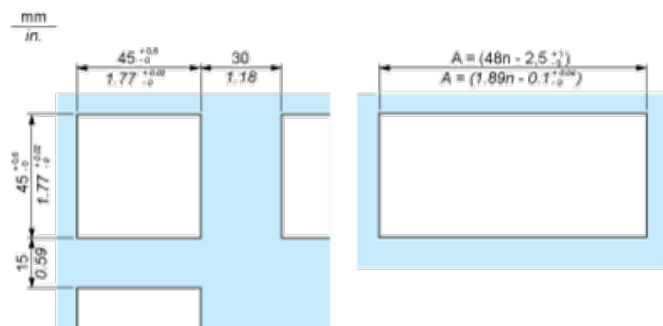

n Number of devices mounted side-by-side

Mounting

Cover positioning and mounting

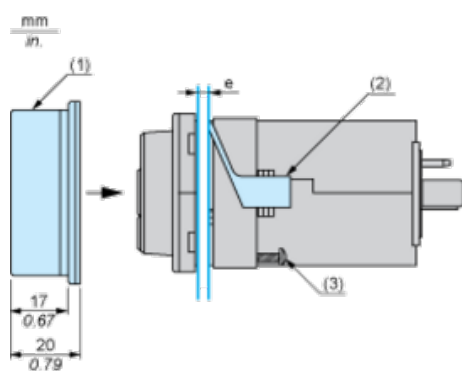

e Panel thickness

1 Protective cover

2 Panel mounting frame

3 Locating screw

Wiring Diagram

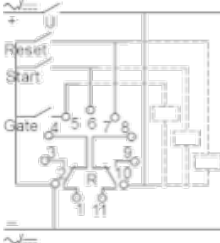

Function A : Power on Delay Relay

Description

The timing period T begins on energisation. After timing, the output R closes.

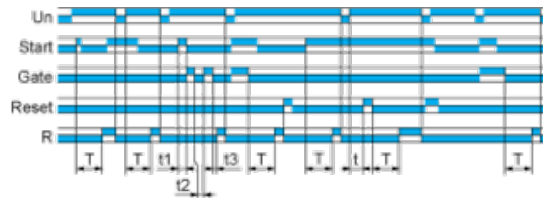

$$T = t1 + t2 + t3$$

Function B : Interval Relay with Control Signal

Description

After power-up, pulsing or maintaining control contact C starts the timing T. The output R closes for the duration of the timing period T then reverts to its initial state.

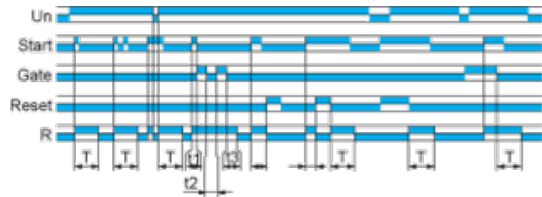

$$T = t1 + t2 + t3$$

Function C : Off-Delay Relay with Control Signal

Description

After power-up and closing of the control contact, the output closes. When control contact re-opens, timing T starts. At the end of the timing period, the output reverts to their initial state.

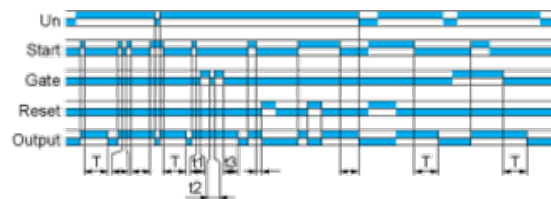

$$T = t1 + t2 + t3$$



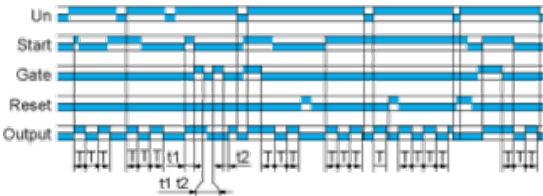

Function Di : Symmetrical Flasher Relay (Starting Pulse On)

Description

Repetitive cycle with two timing periods T of equal duration, with output changing state at the end of each timing period T.



Legend

-  Relay de-energised
-  Relay energised
-  Output open
-  Output closed

C	Control contact
G	Gate
R	Relay or solid state output
R1/R2	2 timed outputs
R2 inst.	The second output is instantaneous if the right position is selected
T	Timing period
Ta -	Adjustable On-delay
Tr -	Adjustable Off-delay
U	Supply