

Product data sheet

Characteristics

QOB340

Mini circuit breaker, QO, 40A, 3 pole, 120/240 VAC, 10 kA, bolt on mount

Product availability : Stock - Normally stocked in distribution facility



Price* : 316.44 USD



Main

Product	Miniature circuit-breaker
Range	QO
Current Rating	40 A
Voltage Rating	120/240 V AC 240 V AC 120 V AC 48 V DC
Mounting Type	Bolt-on
Number of Poles	3P
Circuit Breaker Type	Standard
Ratings	HACR rated
Electrical Connection	Box lugs

Complementary

Interrupt Rating	10 kA 120/240 V AC 50/60 Hz 10 kA 240 V AC 50/60 Hz 10 kA 120 V AC 50/60 Hz 5 kA 48 V DC
Number of Panel Spaces	3
Wire Size	AWG 8...AWG 2 copper or aluminium
Tightening Torque	44.25 lbf.in (5 N.m) 0.02...0.04 in ² (10...25 mm ²) (AWG 8...AWG 2)
Height	3.12 in (79.25 mm)
Width	2.25 in (57.15 mm)
Depth	2.91 in (73.91 mm)

* Price is "List Price" and may be subject to a trade discount – check with your local distributor or retailer for actual price.

Environment

Certifications	UL Listed CSA
Ambient Rating	104 °F (40 °C)

Ordering and shipping details

Category	00015 - QOB CIRCUIT BREAKERS
Discount Schedule	DE2
GTIN	00785901417149
Nbr. of units in pkg.	1
Package weight(Lbs)	12.80 oz (363 g)
Returnability	Yes
Country of origin	MX

Packing Units

Unit Type of Package 1	PCE
Package 1 Height	2.30 in (5.842 cm)
Package 1 width	3.50 in (8.89 cm)
Package 1 Length	3.50 in (8.89 cm)
Unit Type of Package 2	BB1
Number of Units in Package 2	3
Package 2 Weight	2.60 lb(US) (1.179 kg)
Package 2 Height	3.70 in (9.398 cm)
Package 2 width	3.50 in (8.89 cm)
Package 2 Length	7.10 in (18.034 cm)
Unit Type of Package 3	CAR
Number of Units in Package 3	36
Package 3 Weight	31.90 lb(US) (14.47 kg)
Package 3 Height	3.70 in (9.398 cm)
Package 3 width	14.40 in (36.576 cm)
Package 3 Length	21.60 in (54.864 cm)

Offer Sustainability

Sustainable offer status	Green Premium product
REACH Regulation	REACH Declaration
REACH free of SVHC	Yes
EU RoHS Directive	Compliant EU RoHS Declaration
Mercury free	Yes
RoHS exemption information	Yes
China RoHS Regulation	China RoHS declaration Product out of China RoHS scope. Substance declaration for your information.
Environmental Disclosure	Product Environmental Profile
Halogen content performance	Halogen free product

Contractual warranty

Warranty	18 months
----------	-----------

Dimensions

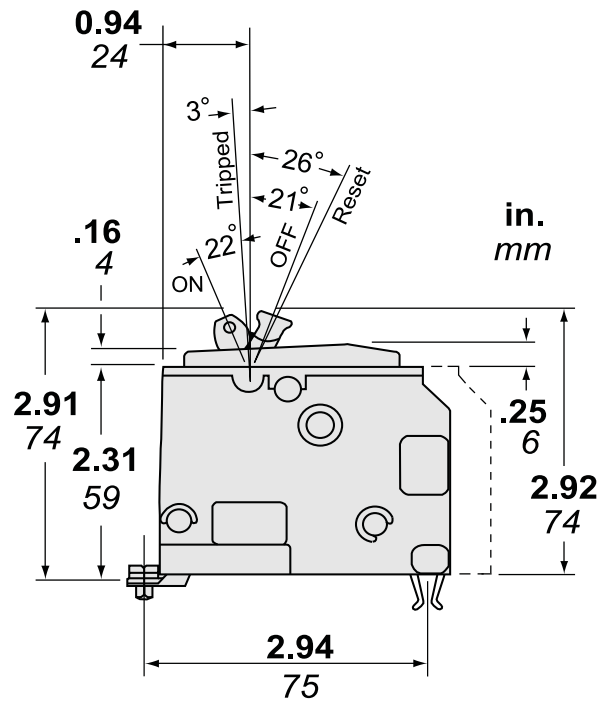
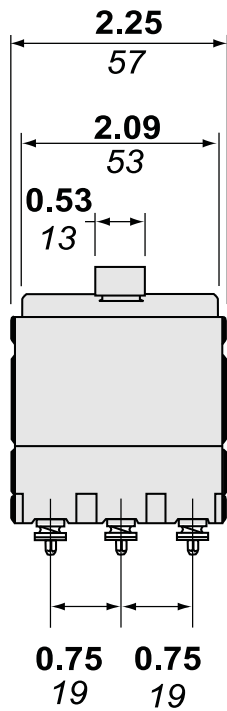
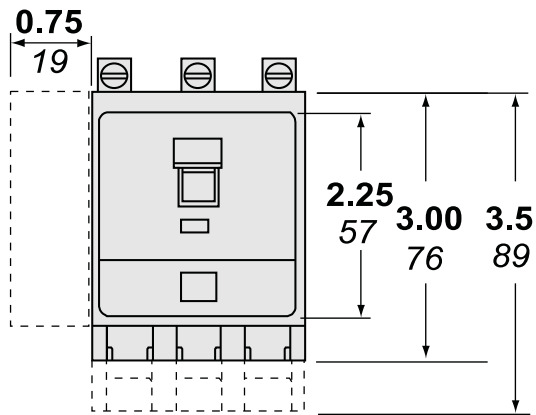

Dimensions are approximate. Refer to technical documentation for additional detail.